

FT SERIES

寶獅牌工業用縫紉機 INDUSTRIAL SEWING MACHINE

**MODEL
FT7000**



**HIGH SPEED FLAT BED
INTERLOCK MACHINE**

Parts List



精機機械廠股份有限公司 CHING CHI MACHINE CO., LTD
<http://www.kingtensexing.com.tw>

Ver 3.0 2022.08
NO.FT6301-1G-06-10

CONTENTS

序號 Ref. No.	名 稱 Description	頁 次 Page No.
1	FT7000 本體與外裝零件 Frame Components For FT7000 (A) -----	1
2	FT7000 本體與外裝零件 Frame Components For FT7000 (B) -----	3
3	FT7000 導線與張力調整零件 Thread Guide And Tension Components For FT7000 -----	5
4	FT7000 軸襯與油封 Bushing And Seal For FT7000 -----	7
5	FT7000 下軸與相關零件 Lower Main Shaft Components -----	9
6	FT7000 上軸與相關零件 Upper Main Shaft Components For FT7000 ---	11
7	FT7000 / FTD7000 針棒與相關零件 Needle Bar Components For FT7000 / FTD7000 -----	13
8	FT4600/FT4700/FT6200/FT6500/FT7000 壓腳與相關零件 Presser Foot Components For FT4600/FT4700/FT6200/FT6500/FT7000 -	15
9	FT7000 / FTD7000 裝飾線驅動機構 Spreader Mechanism For FT7000 / FTD7000 -----	17
10	FT7000 / FTD7000/ FTU7011 結線鉤驅動機構 Looper Driving Mechanism -----	19
11	FT7000 / FTD7000 / FTU7011 / FTK2500 進給變換機構 Feed Control Driving -----	21
12	FT7000 / FTD7000 / FTU7011 導針與送布齒驅動機構 Needle Guide And Feed Dog Driving For FT7000 / FTD7000 / FTU7011 -----	23
13	FT7000 潤滑系統 Lubrication System For FT7000 -----	25
14	66707 線架 Thread Stand For 66707 -----	27
15	FT7000 裝載附件 Supporting Board For FT7000 -----	29
16	FT7000 工具及附件 Accesseries For FT7000 -----	31
17	車型定規列表 Gauge Parts List -----	33

1. FT7000 本體與外裝零件 Frame Components For FT7000 (A)

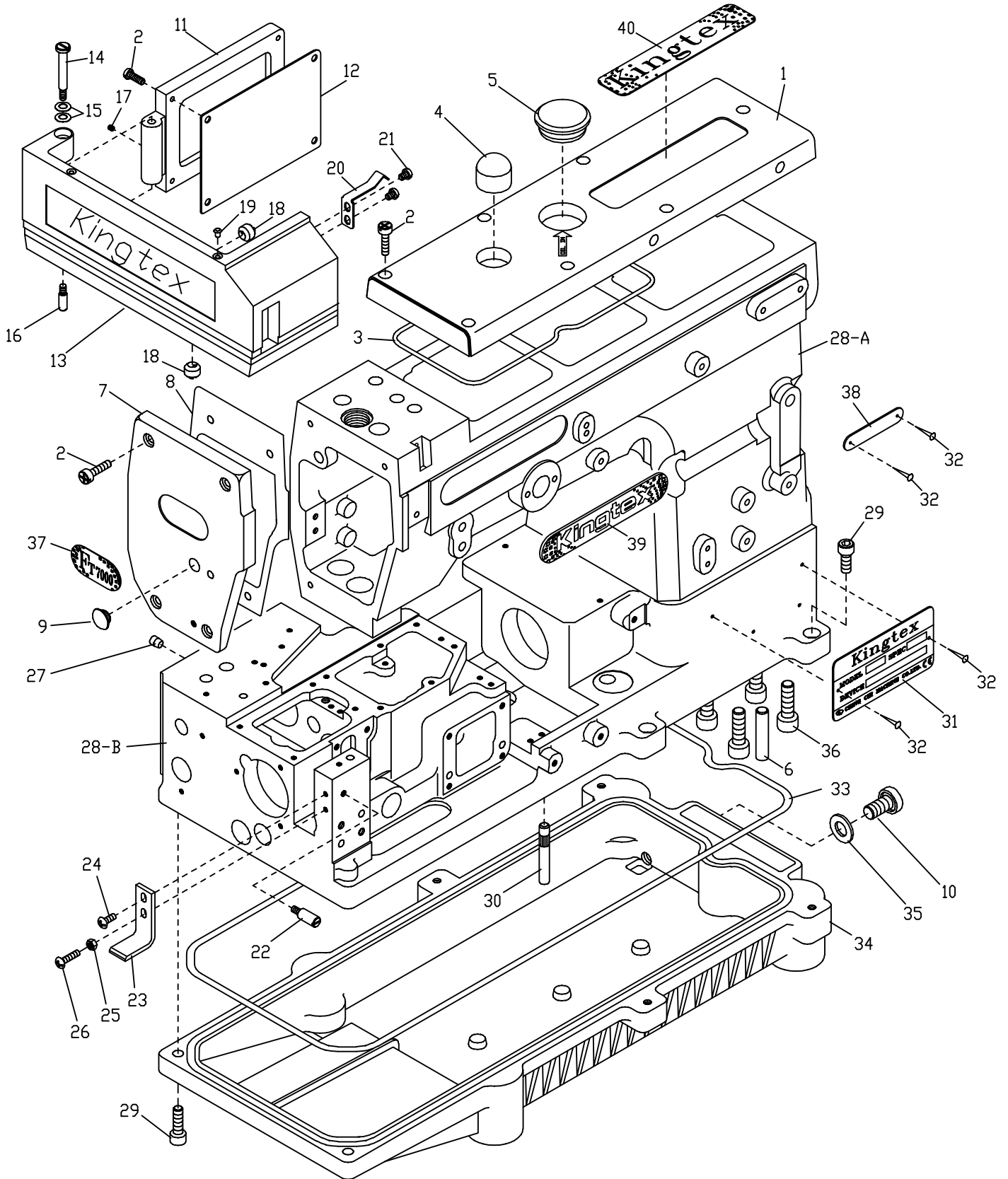

1. FT7000 本體與外裝零件 Frame Components For FT7000 (A)

序號 Ref. No.	物料編號 Parts No.	名稱 Description	單位用量 Amt.Req.
1	2220000101	上軸蓋 Top Cover -----	1
2	8MC04281207D	螺絲 Screw (CT0102 M4-0.7*12) -----	15
3	22000001031	油封 Gasket (CT0103) -----	1
4	2200000104	油鏡 Oil Window (CT0104) -----	1
5	22000001051	孔塞 Plug (CT01051)-----	1
6	2200000139	定位銷 Knock Pin (CT0139)-----	2
7	2220000107	針棒蓋 Needle Cover -----	1
8	2200000108	油封 Gasket -----	1
9	22000001091	孔塞 Plug (CT01091) -----	1
10	8SM95281017A	螺椿 Stud (SH0243 3/8"-28*10) -----	1
11	2210000111	封蓋 Oil Filter Cover -----	1
12	22100001121	油封 Gasket -----	1
13	2280000113	側蓋 Oil Filter Cover -----	1
14	8MB04283809E	螺椿 Stud (CT0227 M4-0.7*38) -----	1
15	2200000228	孟形墊圈 Disk Washer (CT0228) -----	2
16	8MB04280605M	螺椿 Stud (CT0230 M4-0.7*6) -----	1
17	8MN04280400A	螺絲 Screw (CT0229 M4-0.7*4) -----	1
18	2210000118	減震橡膠 Rubber Cushion -----	2
19	22100001191	減震橡膠 Rubber Cushion -----	2
20	2210000120	夾簧 Latch Spring -----	1
21	8MC04280507D	螺絲 Screw (CT0122 M4-0.7*8) -----	2
22	8MB04280707M	螺椿 Stud (FT0122 M4-0.7*21) -----	1
23	2280000123	支架 Side Cover Holder -----	1
24	8MC04280807D	螺絲 Screw (CT0130 M4-0.7*8) -----	1
25	8MA04280307A	螺帽 Nut (CT0238 M4-0.7*3) -----	1
26	8MB04281607A	螺絲 Screw (CT0724 M4-0.7*16) -----	1
27	2200000136	孔塞 Plug (CT0136) -----	1
28	2280000128	車頭 Frame Unit -----	-
28-A	2270000135A	車頭上座 Frame Unit -----	1
28-B	2280000128B	車頭下座 Frame Unit -----	1
29	8MM06402010A	螺絲 Screw (SH0444 M6-1*20) -----	6
30	2210000130	下座腳椿 Supporting Bar -----	4
31	66485-1	車型銘板 Model Plate -----	1
32	66620	鉚釘 Rivet (6620) -----	4
33	2210000133	油封 Gasket -----	1
34	2210000134	油盤 Oil Reservoir -----	1
35	2100000244	油封 Seal (SH0244)-----	1
36	8MM10603016A	螺絲 Screw (CT0138 M10-1.5*30) -----	4
37	66485-3	針棒蓋銘板 Model Plate -----	1
38	66480-14	機器號碼牌 Machine No. Plate -----	1
39	66485-4	上車頭銘板 Model Plate -----	1
40	66485-5	上蓋銘板 Top Cover Plate -----	1

2. FT7000本體與外裝零件 Frame Components For FT7000 (B)

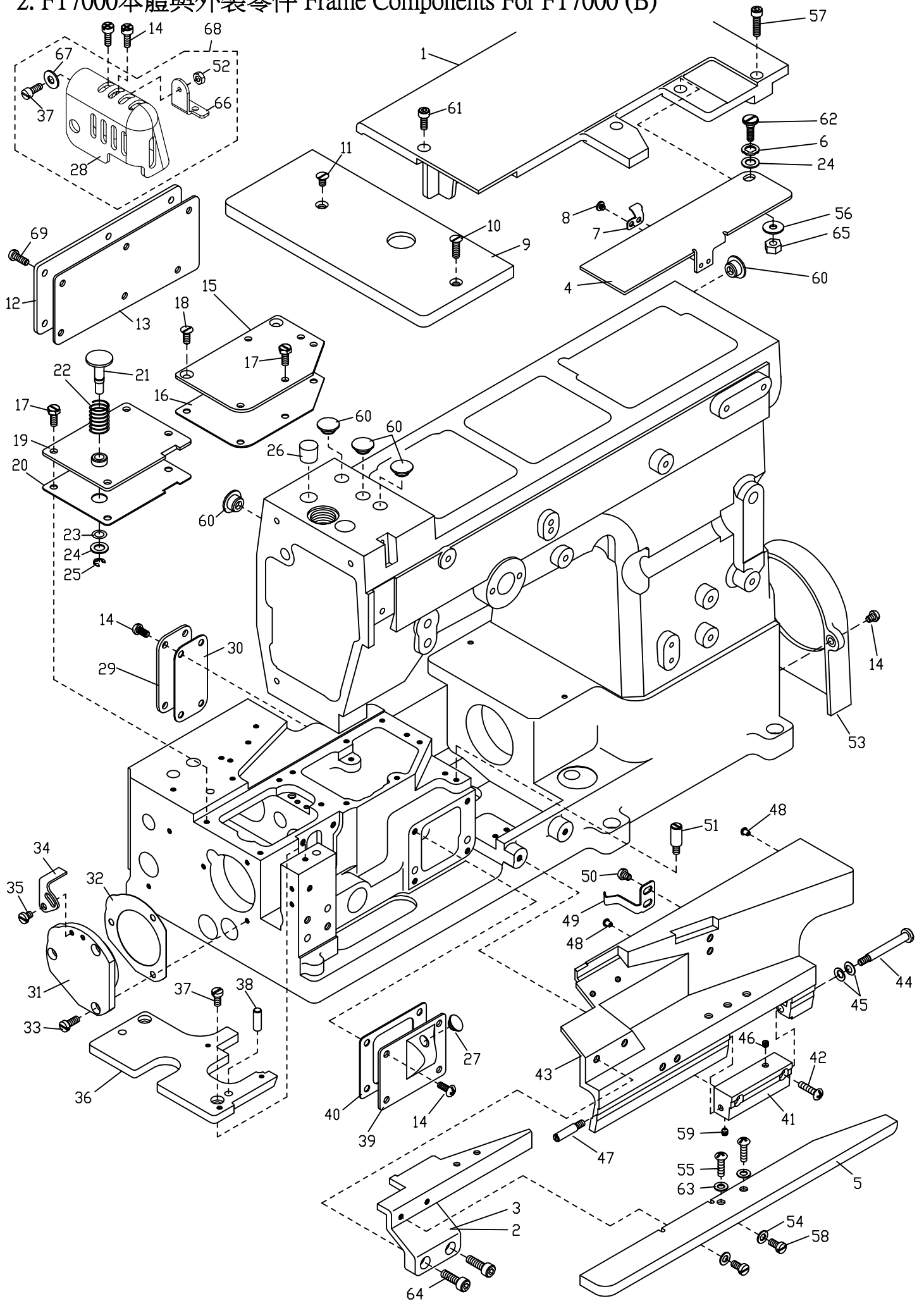

2. FT7000 本體與外裝零件 Frame Components For FT7000 (B)

序號 Ref. No.	物料編號 Parts No.	名稱 Description	單位用量 Amt.Req.
1	2210000201	封蓋 Rear Cover -----	1
*2	2280000202	下座前蓋活動塊 Movable Block -----	1
**3	2280000203	下座前蓋活動塊 Movable Block -----	1
4	22100002041	護線蓋 Cloth Plate -----	1
5	2280000205	下座前蓋支架 Front Cove Holder -----	1
6	90WW060	波型墊圈 Wave Washer -----	1
7	2210000207	夾簧 Latch Spring -----	1
8	8MB03200306A	螺絲 Screw (FT0208 M3-0.5*2.5) -----	2
9	2280000209	左布板 Cloth Plate -----	1
10	8ME04281408A	螺絲 Screw (CT1140 M4-0.7*14) -----	1
11	8ME04280708A	螺絲 Screw (CT0206 M4-0.7*7) -----	1
12	2200000210	封蓋 Rear Cover (CT0210) -----	1
13	22000002091	油封 Gasket (CT0209)-----	1
14	8MC04280807D	螺絲 Screw (CT0130 M4-0.7*8) -----	12
15	2210000215	封蓋 Oil Filter Cover -----	1
16	22100002161	油封 Gasket -----	1
17	8MK04281007A	螺絲 Screw (FT0217 M4-0.7*10) -----	9
18	8ME04281008A	螺絲 Screw (FT0218 M4-0.7*10) -----	2
19	22100002191	封蓋 Oil Filter Cover -----	1
20	22100002201	油封 Gasket -----	1
21	2210000221	止動銷 Stopper Pin -----	1
22	2210000222	彈簧 Spring -----	1
23	90OR060	油環 OIL Rin (P6)-----	1
24	2200000910	墊圈 Washer (CT0910) -----	2
25	90ER040	E形扣環 E Ring -----	1
26	22000002081	孔塞 Plug (CT02081) -----	1
27	22100002271	孔塞 Plug (FT02271) -----	1
28	22700002121	針棒護蓋 Needle Bar Protector -----	1
29	2210000229	封蓋 Oil Filter Cover -----	1
30	22100002301	油封 Gasket -----	1
31	2210000231	軸承座 Crankshaft Bushing -----	1
32	22100002321	油封 Gasket -----	1
33	8MB04281007K	螺絲 Screw (CT1237 M4-0.7*10) -----	3
34	2210000234	止動鉤 Pushbutton Stop -----	1
35	8MB04280507K	螺絲 Screw (FT0235 M4-0.7*5) -----	2
36	2210000236	針板座 Needle Plate Seat -----	1
37	8MB04280807K	螺絲 Screw (CT0215 M4-0.7*8) -----	3
38	2200001133	定位銷 Knock Pin -----	2
39	2210000239	封蓋 Oil Filter Cover -----	1
40	2210000240	油封 Gasket -----	1
41	2280000241	絞鏈 Hinge -----	1
42	8MC04281407D	螺絲 Screw (CT0225 M4-0.7*14) -----	2
43	2280000243	下座前蓋 Front Cover -----	1
44	8MB04284209E	螺樁 Stand (FT0244 M4-0.7*42) -----	1
45	2200000228	孟形墊圈 Disk Washer (CT0228) -----	2
46	8MN04280400A	螺絲 Screw (CT0229 M4-0.7*4) -----	1
47	8MB04280705M	螺樁 Stand (FT0247 M4-0.7*7) -----	1
48	22100001191	減震橡膠 Rubber Cushion -----	2
49	2210000249	夾簧 Latch Spring -----	1
50	8MC04280507D	螺絲 Screw (CT0122 M4-0.7*5) -----	2
51	8MB04280707M	螺樁 Stand (FT0122 M4-0.7*7) -----	1
52	8MA04280207A	螺帽 Nut (STC02-01-02 M4-0.7*2.5) -----	1
53	2210000253	冷卻風扇護蓋 Oil Cooling Fan Guard -----	1
54	2100000223	墊圈 Washer -----	2
55	8MC05321209D	螺絲 Screw (F02-55 M5-0.8*12) -----	2
56	2210090124	墊圈 Washer -----	1
57	8MM04281607A	螺絲 Screw (FT0202 M4-0.7*16) -----	3
58	8MB04281207K	螺絲 Screw (CT0239 M4-0.7*12) -----	2
59	8MN04280500C	螺絲 Screw (FT1222 M4-0.7*5) -----	1
60	22000001091	孔塞 Plug (CT01091)-----	5
61	8MM04281007A	螺絲 Screw(FT0203 M4-0.7*10) -----	1
62	8MB95301711G	螺絲 Screw (FT09-01-21 M4.5-0.75*12.5) -----	1
63	2200001025	墊圈 Washer -----	2
64	8MM05321409A	螺絲 Screw (CT0632 M5-0.8*14) -----	2
65	8MA95300307A	螺帽 Nut -----	1
66	2270000211	基座 Base -----	1
67	90DW040	墊圈 Washer -----	1
68	227A0000259	針棒護蓋組 Needle Bar Protector Asm. -----	1
69	8MC04281007D	螺絲 Screw (CT0113 M4-0.7*10) -----	6

* 40M,48M,56M 用 For 40M,48M,56M

** 64M 用 For 64M

3. FT7000 導線與張力調整零件 Thread Guide Tension Components For FT7000

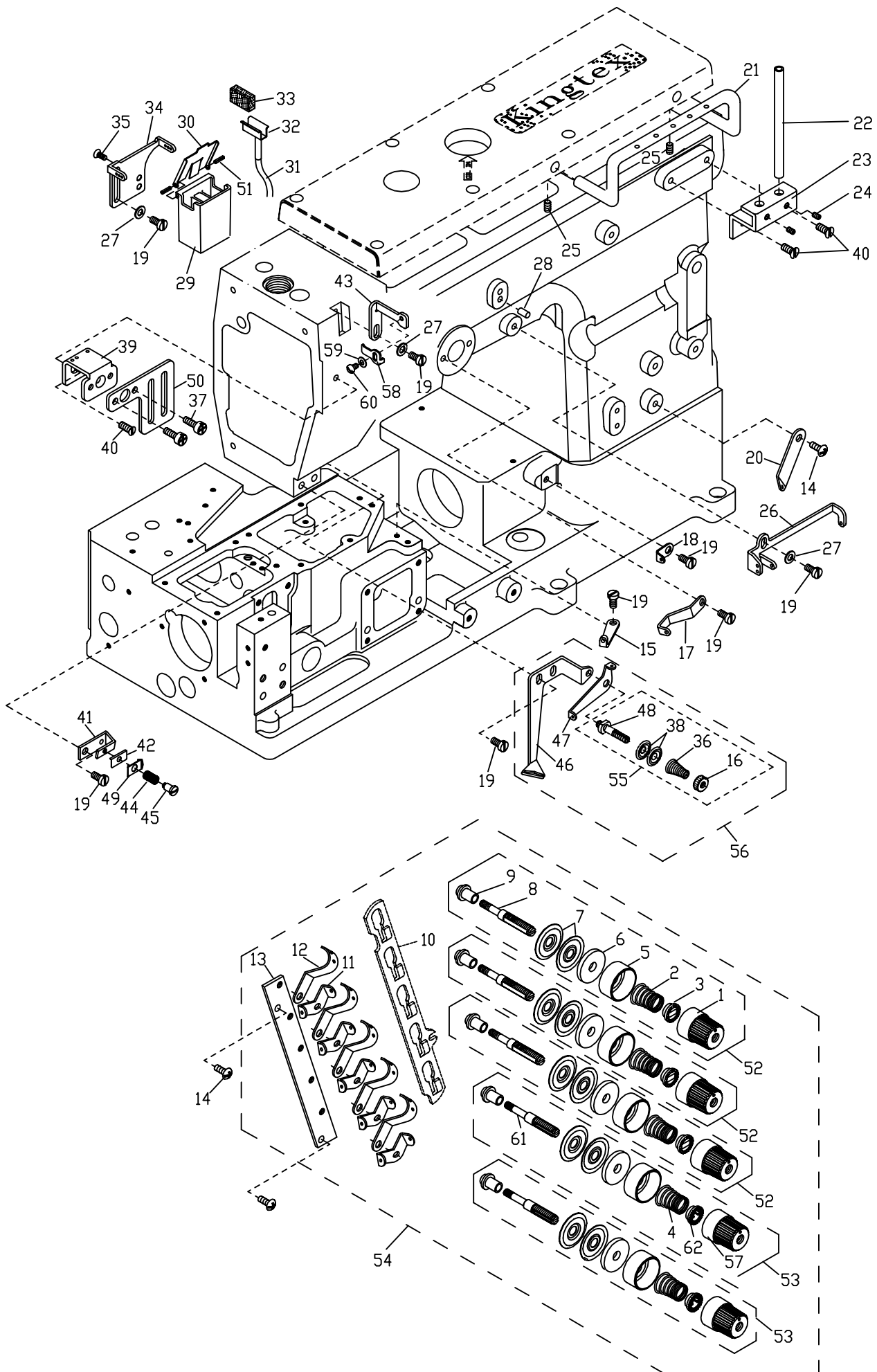

3. FT7000 導線與張力調整零件 Thread Guide And Tension Components For FT7000

序號 Ref. No.	物料編號 Parts No.	名稱 Description	單位用量 Amt.Req.
1	2100001121	張力調整螺帽 Tension Nut (Red) (SH1121)-----	3
2	2100001123	彈簧 Spring (Red) (SH1123)-----	3
3	2200000303	套管 Bushing (CT0303)-----	3
4	2100041131	彈簧 Spring (Yellow) (SH1131)-----	2
5	2200000305	彈簧座 Spring Seat (CT0305)-----	5
6	2100001127	羊毛氈 Felt (SH1127)-----	5
7	2100001126	張力控制盤 Tension Disc (SH1126)-----	10
8	22000003081	螺樁 Stud -----	3
9	22000003091	隔環 Spacer -----	5
10	2220000310	鬆線滑板 Release Wedge -----	1
11	2200000311	導線 Thread Guide (CT0311)-----	5
12	2200000312	導線 Thread Guide (CT0312)-----	5
13	2220000313	張力控制組座 Tension Post Support -----	1
14	8MC04280807D	螺絲 Screw (CT0130 M4-0.7*8)-----	3
15	2210000315	導線 Thread Guide -----	1
16	2200000357	螺帽 Nut (CT0357)-----	1
17	2210000317	導線 Thread Guide -----	1
18	2210000318	導線 Thread Guide -----	1
19	8MB04280807K	螺絲 Screw (CT0215 M4-0.7*8)-----	9
20	2200000317	導線 Thread Guide (CT0317)-----	1
21	2220000331	導線桿 Thread Guide -----	1
22	2200000327	導線管 Thread Guide Pipe -----	2
23	2220000328	導線座 Thread Guide Holder -----	1
24	8MN03200500A	螺絲 Screw (STB0116 M3-0.5*5)-----	2
25	8MN04280600A	螺絲 Screw (CT1223 M4-0.7*6)-----	2
26	2210000326	導線 Thread Guide -----	1
27	2100000223	墊圈 Washer W3 -----	3
28	90ST0410	定位銷 Knock Pin -----	1
29	22000003351	油杯 Cooler Oil Tank (CT0335)-----	1
30	2200000336	油杯蓋 Cooler Oil Tank Cover (CT0336)-----	1
31	66800	油線 Oil Wick -----	1
32	2200000338	線夾 Wick Clamp (CT0338)-----	1
33	2200000339	羊毛氈 Felt (CT0339)-----	1
34	2200000340	導線 Thread Guide (CT0340)-----	1
35	8TE03440806A	螺絲 Screw -----	2
36	2200000356	彈簧 Spring (CT0356)-----	1
37	8MC04280507D	螺絲 Screw (CT0122 M4-0.7*5)-----	2
38	2200000355	張力控制盤 Tension Disc (CT0355)-----	2
39	2200000345	導線 Thread Guide (CT0345)-----	1
40	8ME04280708A	螺絲 Screw (CT0206 M4-0.7*7)-----	3
41	2200000347	張力控制組座 Thread Retainer Support (CT0347)-----	1
42	2200000348	針線控制板 Thread Guide Plate (CT0348)-----	1
43	2230000343	導線 Thread Guide -----	1
44	22000003501	彈簧 Spring (CT0350)-----	1
45	8MC03200807G	螺樁 Stud (CT0351 M3-0.5*8)-----	1
46	2210000346	導線 Thread Guide -----	1
47	2200000353	導線 Thread Guide (CT0353)-----	1
48	2200000354	螺樁 Stud (CT0354)-----	1
49	2200000349	針線控制壓板 Tension Control plate (CT0349)-----	1
50	2200000359	揚線臂護線罩 Takeup Arm Protect (CT0359)-----	1
51	90SP0206T	彈簧銷 Spring Pin (CT0360)-----	2
52	231A0001922	張力控制組 Tension Asm. (Red)-----	3
53	220A0000315	張力控制組 Tension Asm. (Yellow)-----	2
54	222A0000370	鬆線組 Thread Tension Mechanism Asm.-----	1
55	227A0000342	張力控制組 Thread Retainer Asm -----	1
56	221A0000356	鬆線組 Thread Tension Mechanism Asm. (F0346A)-----	1
57	2100001121A	張力調整螺帽 Tension Nut (Yellow) (SH1121)-----	2
58	2600000307	導線 Thread Guide -----	1
59	90DW030	碟形墊圈 Disk Washer -----	1
60	8MB03200506K	螺絲 Screw (CT0525 M3-0.5*5)-----	1
61	22000003611	螺樁 Stud -----	2
62	2100001122	止滑齒輪 Bush -----	2

4. FT7000 軸襯與油封 Bushing And Seal For FT7000

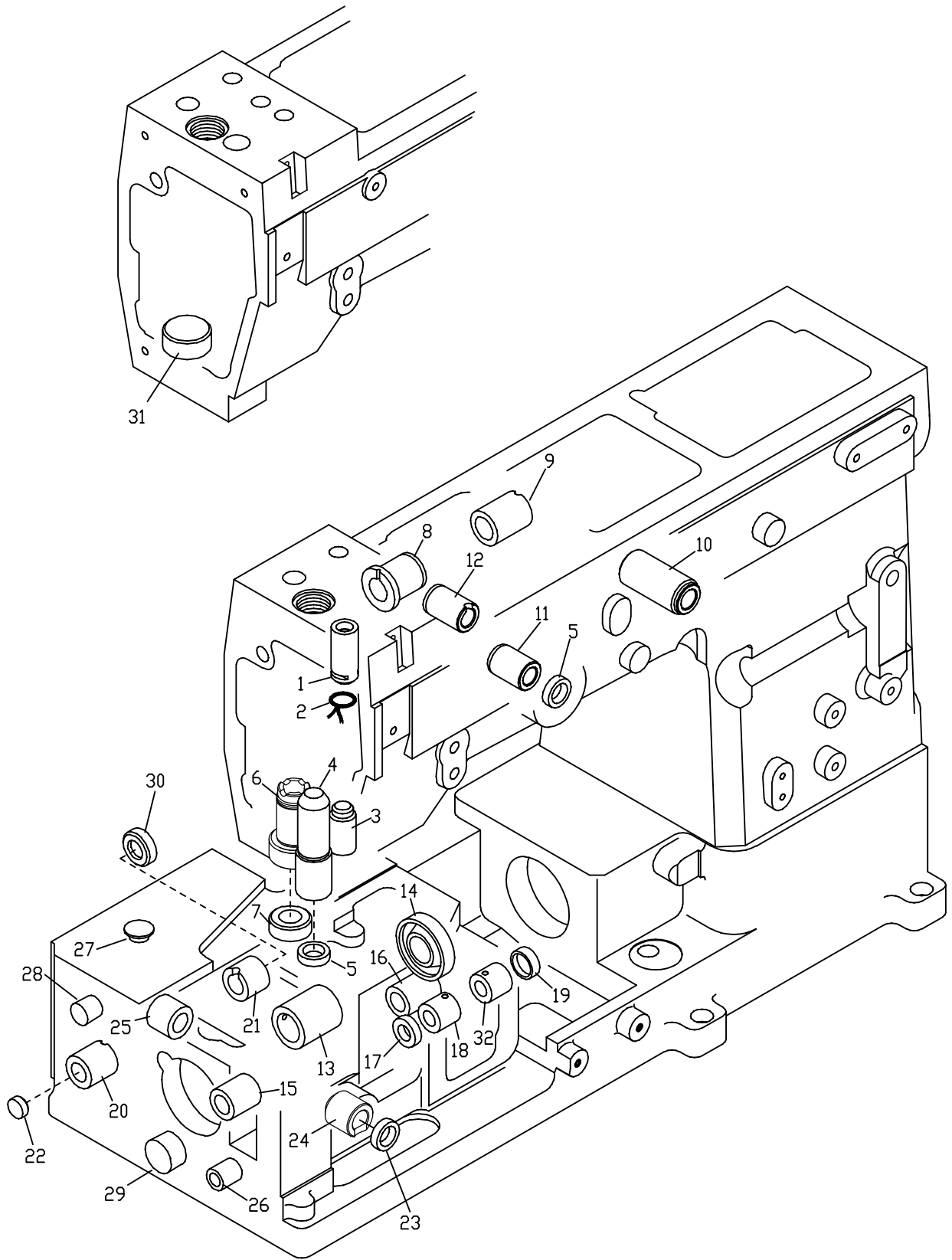

4. FT7000 軸襯與油封 Bushing And Seal For FT7000

序號 Ref. No.	物料編號 Parts No.	名稱 Description	單位用量 Amt.Req.
1	2210000401	軸襯 Bushing -----	1
2	66800	油線 Oil Wick -----	1
3	2210000403	軸襯 Bushing -----	1
4	2210000404	軸襯 Bushing -----	1
5	2200000404	油封 Oil Seal (CT0404) -----	2
*6	22200004051	軸襯 Bushing -----	1
*7	2200000406	油封 Oil Seal (CT0406) -----	1
*8	2210000408	軸襯 Bushing -----	1
*9	2200000408	軸襯 Bushing (CT0408) -----	1
10	2200000409	軸襯 Bushing (CT0409) -----	1
11	22000004101	軸襯 Bushing (CT0410) -----	1
12	2200000411	軸襯 Bushing (CT0411) -----	1
13	2210000413	軸襯 Bushing -----	1
14	2210000414	油封 Oil Seal -----	1
15	2210000415	軸襯 Bushing -----	1
16	2210000416	軸襯 Bushing -----	1
17	2210000417	油封 Oil Seal -----	1
18	2210000418	軸襯 Bushing (Left) -----	1
19	22100004191	孔塞 Plug -----	1
20	22100004201	軸襯 Bushing -----	1
21	22100004211	軸襯 Bushing -----	1
22	22100004221	孔塞 Plug -----	1
23	2210000423	油封 Oil Seal -----	1
24	22100004241	軸襯 Bushing -----	1
25	2210000425	軸襯 Bushing -----	1
26	2210000426	軸襯 Bushing -----	1
27	22000001091	孔塞 Plug (CT01091) 灰色 -----	1
28	22000002081	孔塞 Plug (CT02081) 灰色 -----	1
29	22100004291	孔塞 Plug -----	1
30	22100004301	孔塞 Plug -----	1
**31	2200000422	孔塞 Plug (CT0422) -----	1
32	2210000432	軸襯 Bushing (Right) -----	1

*具有上飾線 With top cover thread

**不具有上飾線 Without top cover thread

5. FT7000 下軸與相關零件 Lower Main Shaft Components

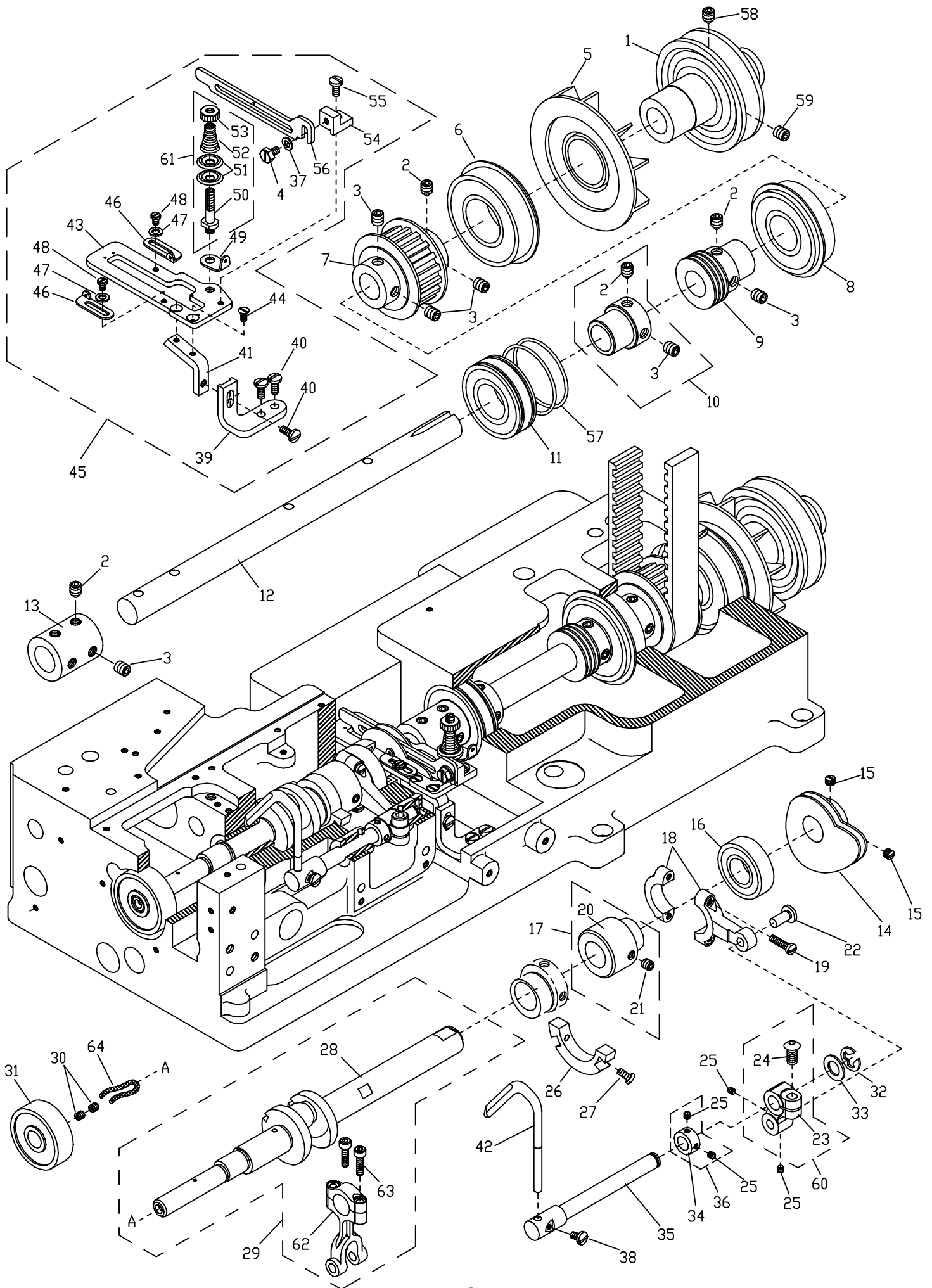

5. FT7000 下軸與相關零件 Lower Main Shaft Components

序號 Ref. No.	物料編號 Parts No.	名稱 Description	單位用量 Amt.Req.
1	2210000501	皮帶輪 Belt Pulley -----	1
2	8MN06400800C	螺絲 Screw (FT0502 M6-1*8) -----	5
3	8MN06400600A	螺絲 Screw (C0244 M6-1*6) -----	7
4	8MK85240807A	螺絲 Screw (FT70504 M3.5-0.6*6) -----	1
5	2210000505	冷卻風扇 Oil Cooling Fan -----	1
6	90BB2552154	滾珠軸承 Ball Bearing (CT0504) -----	1
7	2200000505	齒形皮帶輪 Timing Pulley (CT0505) -----	1
8	90BB2047144	滾珠軸承 Ball Bearing (CT0506) -----	1
9	2210000509	蝸桿 Worm -----	1
10	2210000610	套管 Bushing -----	1
11	90BB2042126	滾珠軸承 Ball Bearing -----	1
12	2210000512	軸 Shaft -----	1
13	2210000513	連軸器 Shaft Joint -----	1
14	2210000514	揚線凸輪 Looper Thread Takeup Cam -----	1
15	8MH05320400A	螺絲 Screw (C0523 M5-0.8*4) -----	2
16	90BB153209	滾珠軸承 Ball Bearing -----	1
17	221A0000562	偏心輪組 Eccentric Asm. (F0520A) -----	1
18	2210000518	連桿 Connecting Rod -----	1
19	8MB85241306K	螺絲 Screw (FT0519 M3.5-0.6*13) -----	2
20	2210000520	偏心輪 Eccentric -----	1
21	8MN05320500E	螺絲 Screw (C0903 M5-0.8*5) -----	2
22	2210000522	連結銷 Connecting Pin -----	1
23	22100005231	曲柄 Lever -----	1
24	8MP05321210A	螺絲 Screw (UTB1-03-40 M5-0.8*11.5) -----	1
25	8MN03200300A	螺絲 Screw (C0115 M3-0.5*3) -----	4
26	2210000526	配重環 Counterweight -----	1
27	8MB03200606K	螺絲 Screw (C1207 M3-0.5*6) -----	2
28	2210000528	曲軸 Crank Shaft -----	1
29	221A0000529	曲軸組 Crank Shaft Asm. -----	1
30	8MN04280400A	螺絲 Screw (C0229 M4-0.7*4) -----	2
31	90BB103511	滾珠軸承 Ball Bearing -----	1
32	90ER060	E形扣環 E Ring -----	1
33	2210000533	墊圈 Washer -----	1
34	2210000534	定位環 Collar -----	1
35	2210000535	後導針器驅動軸 Driving Shaft -----	1
36	221A0000563	定位環組 Collar Asm. (F0534A) -----	1
37	2100000223	墊圈 Washer (W3) -----	1
38	8MB85240407A	螺絲 Screw (FT0538 M3.5-0.6*5) -----	1
39	2210000539	支架 Support -----	1
40	8MB04280807K	螺絲 Screw (C0215 M4-0.7*8) -----	3
41	2210000541	承扳支臂 Support -----	1
42	5221NG00562	後導針器 Needle Guide (NGF00D2) -----	1
43	2210000543	導線承板 Thread Guide Seat -----	1
44	8ME03200606A	螺絲 Screw (C0235 M3-0.5*6) -----	2
45	221A0000545	導線組 Thread Guide Asm. (F0539A) -----	1
46	2210000546	導線 Thread Guide -----	2
47	2210000547	墊圈 Washer -----	2
48	8MB03200405A	螺絲 Screw (F0548 M3-0.5*4) -----	2
49	2210000318	導線 Thread Guide -----	1
50	2200000354	螺樁 Stud (CT0354) -----	1
51	2200000355	張力控制盤 Tension Disc (CT0355) -----	2
52	2200000356	錐形彈簧 Spring (CT0356) -----	1
53	2200000357	螺帽 Nut (CT0357) -----	1
54	2210000554	支架 Support -----	1
55	8MB85240807K	螺絲 Screw (F0555 M3.5-0.6*8) -----	1
56	2210000556	導線 Thread Guide -----	1
57	2200000547	O形油環 O Ring (CT0547) -----	2
58	8MN06401100C	螺絲 Screw (C0548 M6-1*11) -----	1
59	8MN06400800A	螺絲 Screw (C0549 M6-1*8) -----	1
60	221A00005601	曲柄組 Collar Asm. -----	1
61	227A0000342	張力控制組 Thread Retainer Asm -----	1
62	2210001023	連桿 Rod -----	1
63	8MM04281407A	螺絲 Screw (F1003 M4-0.7*14) -----	2
64	66800	油線 Oil Wick -----	1

6. FT7000 上軸與相關零件 Upper Main Shaft Components For FT7000

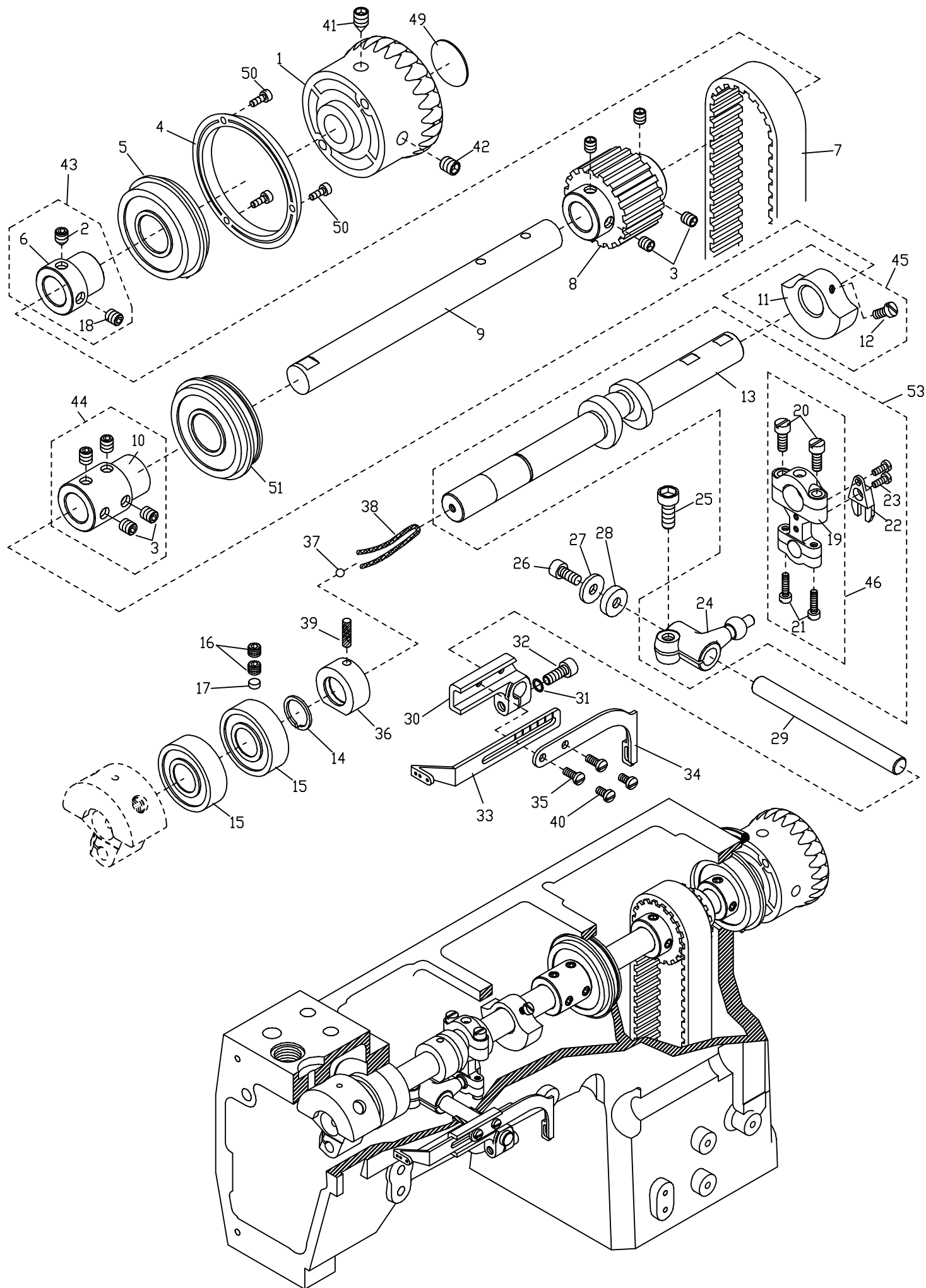

6. FT7000 上軸與相關零件 Upper Main Shaft Components For FT7000

序號 Ref. No.	物料編號 Parts No.	名稱 Description	單位用量 Amt.Req.
1	2280000601	手輪 Handwheel -----	1
2	8MN05320600C	螺絲 Screw (CT350248 M5-0.8*6) -----	1
3	8MN06400600A	螺絲 Screw (CT0244 M6-1*6) -----	8
4	2220000604	軸端封蓋 Cover -----	1
5	90BB2047144	滾珠軸承 Ball Bearing (CT0506) -----	1
6	2200000606	套管接頭 Joint (CT0606) -----	1
7	2200000607	齒形皮帶 Timeing Belt (CT0607) -----	1
8	2200000608	齒形皮帶輪 Timeing Pulley (CT0608) -----	1
9	22200006091	軸 Shaft -----	1
10	2200000610	套管接頭 Joint (CT0610) -----	1
11	2200000509	平衡錘 Balance Weight (CT0509) -----	1
12	8MB04280807K	螺絲 Screw (C0215 M4-0.7*8) -----	2
13	2210000613	曲軸 Crank Shaft -----	1
14	90SCR150	C形軸用扣環 C Ring (CT0614) -----	1
15	90BB1535115	滾珠軸承 Ball Bearing (CT0615) -----	2
16	8MN06400500A	螺絲 Screw (C0513 M6-1*5) -----	2
17	2200000617	墊片 Rubber Seat (CT0617) -----	1
18	8MN05320600A	螺絲 Screw (MT0729 M5-0.8*6) -----	1
19	2200000619	連桿 Connecting Rod (CT0619) -----	1
20	8MB95301407K	螺絲 Screw (C0620 M4.5-0.75*14) -----	2
21	8MB85241006K	螺絲 Screw (C0621 M3.5-0.6*10) -----	2
22	2200000622	定向導軌 Orient Guide (CT0622) -----	1
23	8MB03200806A	螺絲 Screw (CT900623 M3-0.5*8) -----	2
24	2200000624	曲柄 Ball Lever (CT0624) -----	1
25	8MM06401610A	螺絲 Screw (C0625 M6-1*16) -----	1
26	8MM05321009A	螺絲 Screw (C0626 M5-0.8*10) -----	1
27	2200000627	墊圈 Washer (CT0627) -----	1
28	2200000628	隔環 Spacer (CT0628) -----	1
29	2200000629	軸 Shaft (CT0629) -----	1
30	2200000630	承座 Bracket (CT0630) -----	1
31	90SW050	彈簧墊圈 Spring Washer (CT0631) -----	1
32	8MM05321409A	螺絲 Screw (C0632 M5-0.8*14) -----	1
33	2200000633	針線揚線桿 Thread Take-up (CT0633) -----	1
*34	2210000634	裝飾線揚線桿 Thread Take-up -----	1
*35	8MB85240806K	螺絲 Screw (C0635 M3.5-0.6*8) -----	2
36	2210000636	聚油環 Oil Sleeve -----	1
37	2100001404	孔塞 Plug (SH1404) -----	1
38	66800	油線 Oil Wick -----	1
39	66800	油線 Oil Wick -----	1
**40	8MB85240607K	螺絲 Screw (C0637 M3.5-0.6*6) -----	2
41	8MN06401100C	螺絲 Screw (C0548 M6-1*11) -----	1
42	8MN06400800A	螺絲 Screw (C0549 M6-1*8) -----	1
43	222A0000645	套管接頭組 Joint Asm -----	1
44	222A0000646	套管接頭組 Joint Asm -----	1
45	222A0000647	平衡錘組 Balance Weight Asm -----	1
46	222A0000648	連桿組 Connecting Rod Asm -----	1
47	-----	-----	-
48	-----	-----	-
49	66480-11	銘板 Plate -----	1
50	8MM03200606A	螺絲 Screw (CT130406 M3-0.5*6) -----	3
51	90BB2047148	滾珠軸承 Ball Bearing -----	1
52	-----	-----	-
53	221A0000653	曲軸組 Crank Shaft Asm. -----	1

*具有上飾線 With top cover thread

**不具有上飾線 Without top cover thread

7. FT7000 / FTD7000 針棒與相關零件 Needle Bar Components For FT7000 / FTD7000

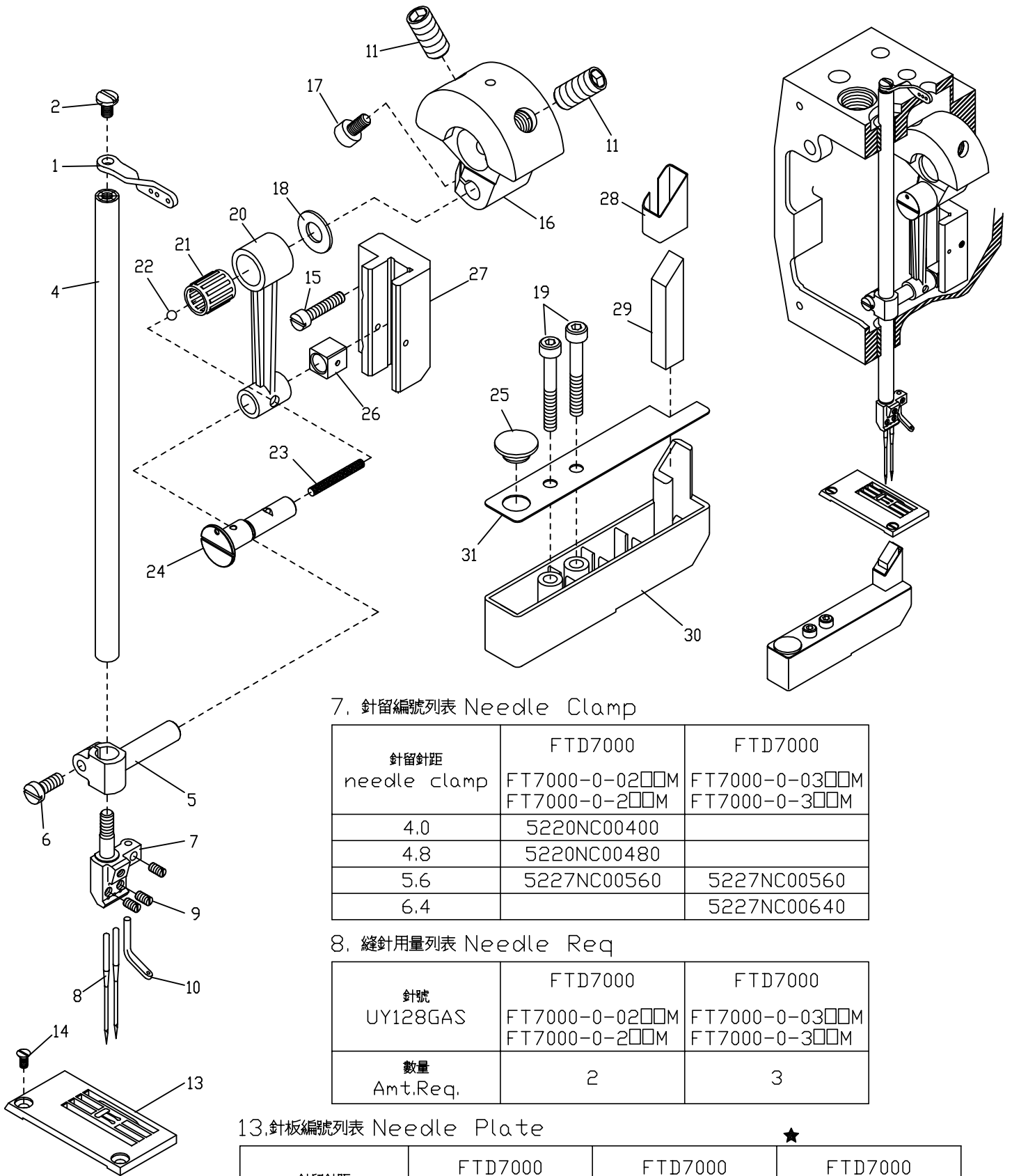

7. 針留編號列表 Needle Clamp

針留針距 needle clamp	FTD7000	FTD7000
	FT7000-0-02□□M FT7000-0-2□□M	FT7000-0-03□□M FT7000-0-3□□M
4.0	5220NC00400	
4.8	5220NC00480	
5.6	5227NC00560	5227NC00560
6.4		5227NC00640

8. 縫針用量列表 Needle Req

針號 UY128GAS	FTD7000	FTD7000
	FT7000-0-02□□M FT7000-0-2□□M	FT7000-0-03□□M FT7000-0-3□□M
數量 Amt.Req.	2	3

13. 針板編號列表 Needle Plate

針留針距 Needle Plate	FTD7000	FTD7000	FTD7000
	FT7000-0-02□□M FT7000-0-2□□M	FT7000-0-03□□M FT7000-0-3□□M	FT7000-0-03□□M FT7000-0-3□□M
4.0	5222TP00401		
4.8	5220TP00484		
5.6	5220TP00564	5220TP00564	5220TP00568
6.4		5220TP00642	5220TP00646

★ 薄類用

7. FT7000 / FTD7000 針棒與相關零件 Needle Bar Components For FT7000 / FTD7000

序號 Ref. No.	物料編號 Parts No.	名稱 Description	單位用量 Amt.Req.
1	2200000703	導線 Thread Guide -----	1
2	8MB85240607K	螺絲 Screw (C0637 M3.5-0.6*6) -----	1
3	-----	-----	-
4	22000007011	針棒 Needle Bar -----	1
5	2210000705	針棒驅動銷 Needle Bar Clamp -----	1
6	8MB95301107K	螺絲 Screw (C0706 M4.5-0.75*11) -----	1
7	-----	針留 Needle clamp (See Left Page) -----	1
8	-----	針 Needle --(UYX128GAS See Left Page) -----	-
9	8SH32440300A	螺絲 Screw (SH0465 1/8"-44*2.5) -----	4
*10	2200000710	導線 Thread Guide (CT0710) -----	1
11	8MN08401600E	螺絲 Screw (CT0618 M8-1*16) -----	2
12	-----	-----	-
13	-----	針板 Needle Plate (See Left Page) -----	1
14	8SF36400706C	螺絲 Screw (C0712 9/64"-40*7) -----	2
15	8MB04281607A	螺絲 Screw (C0724 M4-0.7*16) -----	2
16	2270000714	平衡錘 Balance Weight -----	1
17	8MM05321009A	螺絲 Screw (CT626 M5-0.8*10) -----	1
18	2270000716	墊圈 Washer -----	1
19	8MM04282507B	螺絲 Screw (FT0719 M4-0.7*25) -----	2
20	2210000720	連桿 Connecting Rod -----	1
21	90NB081113	滾針軸承 Ball Bearing (CT0719) -----	1
22	2100001404	孔塞 Plug (SH1404) -----	1
23	66800	油線 Oil Wick -----	1
24	2270000720	曲柄銷 Rod Pin -----	1
25	22000001091	孔塞 Plug (CT01019) -----	1
26	2200000722	滑塊 Slide Block (CT0722) -----	1
27	2210000727	滑道 Guide Block -----	1
28	2210000728	羊毛氈扣環 Felt Guard -----	1
29	2210000729	羊毛氈 Felt -----	1
30	22100007301	冷卻油槽 Cooler Oil Tank -----	1
31	2210000731	冷卻油槽蓋 Cooler Oil Tank Cover -----	1

*具有上飾線 With top cover thread

8. FT4600 / FT4700 / FT6200 / FT6500 / FT7000 壓腳與相關零件

Presser Foot Components For FT4600 / FT4700 / FT6200 / FT6500 / FT7000

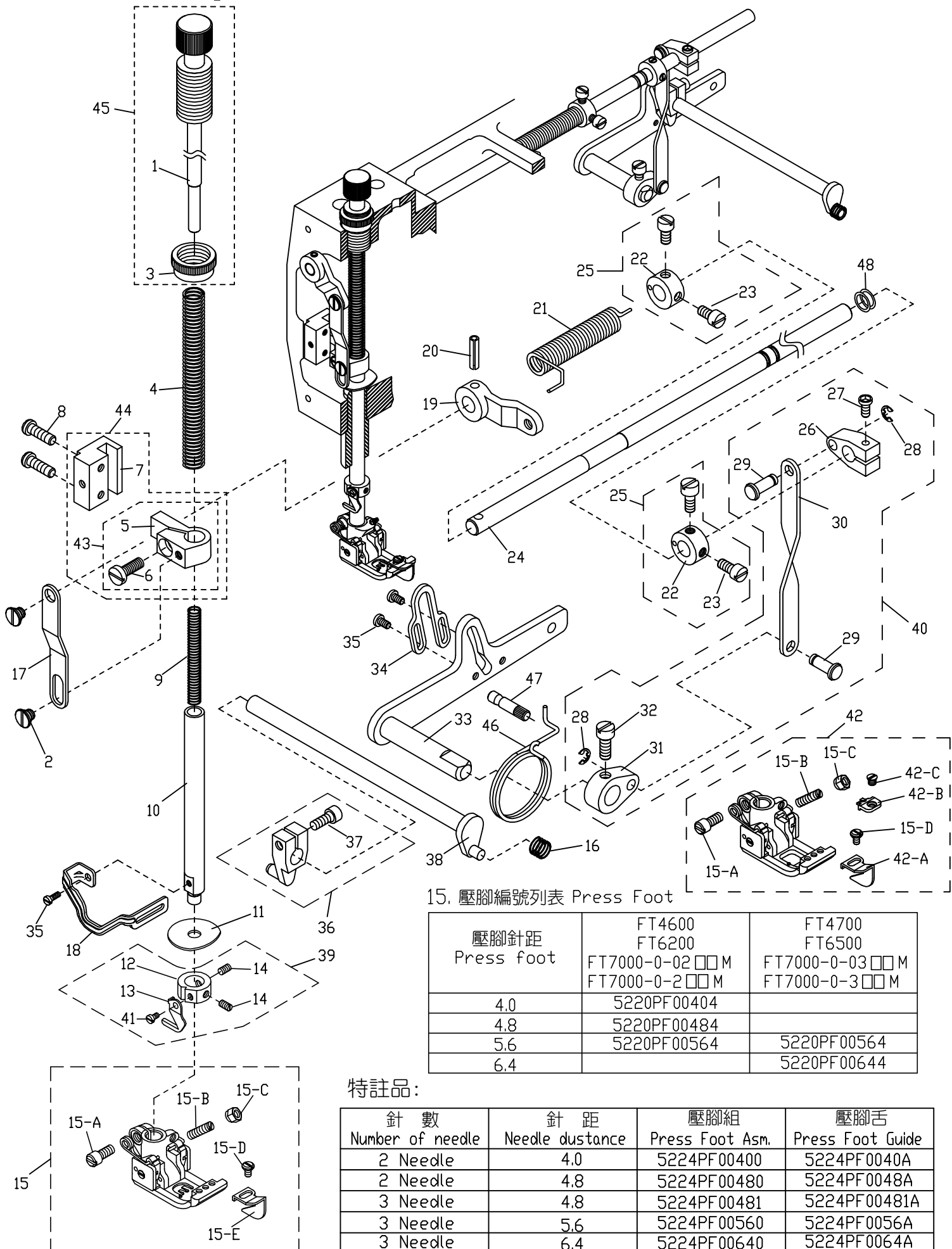

15. 壓腳編號列表 Press Foot

壓腳針距 Press foot	FT4600 FT6200 FT7000-0-02□□M FT7000-0-2□□M	FT4700 FT6500 FT7000-0-03□□M FT7000-0-3□□M
4.0	5220PF00404	
4.8	5220PF00484	
5.6	5220PF00564	5220PF00564
6.4		5220PF00644

特註品:

針數 Number of needle	針距 Needle distance	壓腳組 Press Foot Asm.	壓腳舌 Press Foot Guide
2 Needle	4.0	5224PF00400	5224PF0040A
2 Needle	4.8	5224PF00480	5224PF0048A
3 Needle	4.8	5224PF00481	5224PF00481A
3 Needle	5.6	5224PF00560	5224PF0056A
3 Needle	6.4	5224PF00640	5224PF0064A

8. FT4600 / FT4700 / FT6200 / FT6500 / FT7000 壓腳與相關零件

Presser Foot Components For FT4600 / FT4700 / FT6200 / FT6500 / FT7000

序號 Ref. No.	物料編號 Parts No.	名稱 Description	單位用量 Amt.Req.
1	2280000801	壓力調整螺椿 Spring Regulator -----	1
2	8MB05320509G	螺絲 Screw (CT0802 M5-0.8*5) -----	2
3	2220000803	螺帽 Nut -----	1
4	2210000804	彈簧 Spring -----	1
5	2200000805	壓腳棒連結臂 Presser Bar Clamp -----	1
6	8MC95300808E	螺絲 Screw (CT0806 M4.5-0.75*8) -----	1
7	2200000807	滑道 GuideBlock (CT0807)-----	1
8	8MB95301407K	螺絲 Screw (CT06-20 M4.5-0.75*14) -----	2
9	2210000809	彈簧 Spring -----	1
10	2200000810	壓腳棒 Presser Bar (CT0810) -----	1
11	2200000811	阻油片 Oil Separator -----	1
12	2220000812	限動環 Stop Collar -----	1
13	2220000813	固定切刀 Knife -----	1
14	8MH85240300A	螺絲 Screw (CT0813 M3.5-0.6*3) -----	2
15	-----	壓腳 Presser Foot(See Left Page) -----	1
15-A	5220PF0356M	螺絲 Screw (M3.5-0.6*8) -----	1
15-B	5221PF0956C	螺絲 Screw(1/8"-44*11) -----	1
15-C	5220PF0356D	螺帽 Nut -----	1
15-D	8SB24560405A	螺絲 Screw (SH0413 3/32"-56*4) -----	1
15-E	5220PF0056L	導布定規 Curl Guard -----	1
16	2200000816	彈簧 Spring (CT0816) -----	1
17	2200000817	連桿 Link (CT0817) -----	1
18	2220000818	護指擋片 Safety Plate Holder) -----	1
19	2200000819	連桿 Lever (CT0819) -----	1
20	90SP0416	彈簧銷 Spring Pin(CT0820) -----	1
21	2200000821	彈簧 Spring (CT0821) -----	1
22	2200000822	定位環 Collar (CT0822) -----	2
23	8MC95300606F	螺絲 Screw (CT0823 M4.5-0.75*5.5) -----	4
24	22000008241	軸 Shaft (CT0824) -----	1
25	220A0000825	定位環組 Collar Asm.(CT0822A) -----	2
26	2200000826	連桿 Lever (CT0826) -----	1
27	8MM05321409A	螺絲 Screw (CT0632 M5-0.8*14) -----	1
28	90ER030	E形扣環 E Ring (CT0828) -----	2
29	2200000829	連結銷 Connecting Pin (CT0829) -----	2
30	2200000830	連桿 Link (CT0830) -----	1
31	2200000831	連桿 Lever (CT0831) -----	1
32	8MC06401008E	螺絲 Screw (C0832 M6-1*9.5) -----	1
33	2210000833	揚昇臂 Lifter Arm -----	1
34	2210000834	揚昇臂限位片 Stopper -----	1
35	8MB85240607K	螺絲 Screw (C0637 M3.5-0.6*6) -----	3
36	2200000836	曲柄 Drive Arm (CT0836) -----	1
37	8MK95301407A	螺絲 Screw (C0837 M4.5-0.75*14) -----	1
38	2200000838	曲軸 Shift (CT0838) -----	1
39	222A0000842	限動環組 Stop Collar Asm -----	1
40	220A0000840	連桿組 Link Asm.(CT0826A) -----	1
41	8MB03200405A	螺絲 Screw (FT0548 M3-0.5*4) -----	1
*42	-----	壓腳 Presser Foot(See Left Page) -----	1
*42-A	5224PF0056L	導布定規 Curl Guard -----	1
*42-B	-----	壓腳舌 Press Foot Tongue(See Left Page) -----	1
*42-C	5221PF6056C	螺絲 Screw-----	1
43	220A0000843	壓腳棒連結臂組 Presser Bar Clamp Set -----	1
44	220A0000844	滑道組 Guide Block Set -----	1
45	228A0000845	壓力調整螺椿組 Spring Regulator Set -----	1
46	2270000839	彈簧 Spring -----	1
47	2220000840	銷 Pin -----	1
48	2240000846	O形油環 O Ring -----	2

* 特註品 Custom-made Item

9. FT7000 / FTD7000 裝飾線驅動機構 Spreader Mechanism For FT7000 / FTD7000

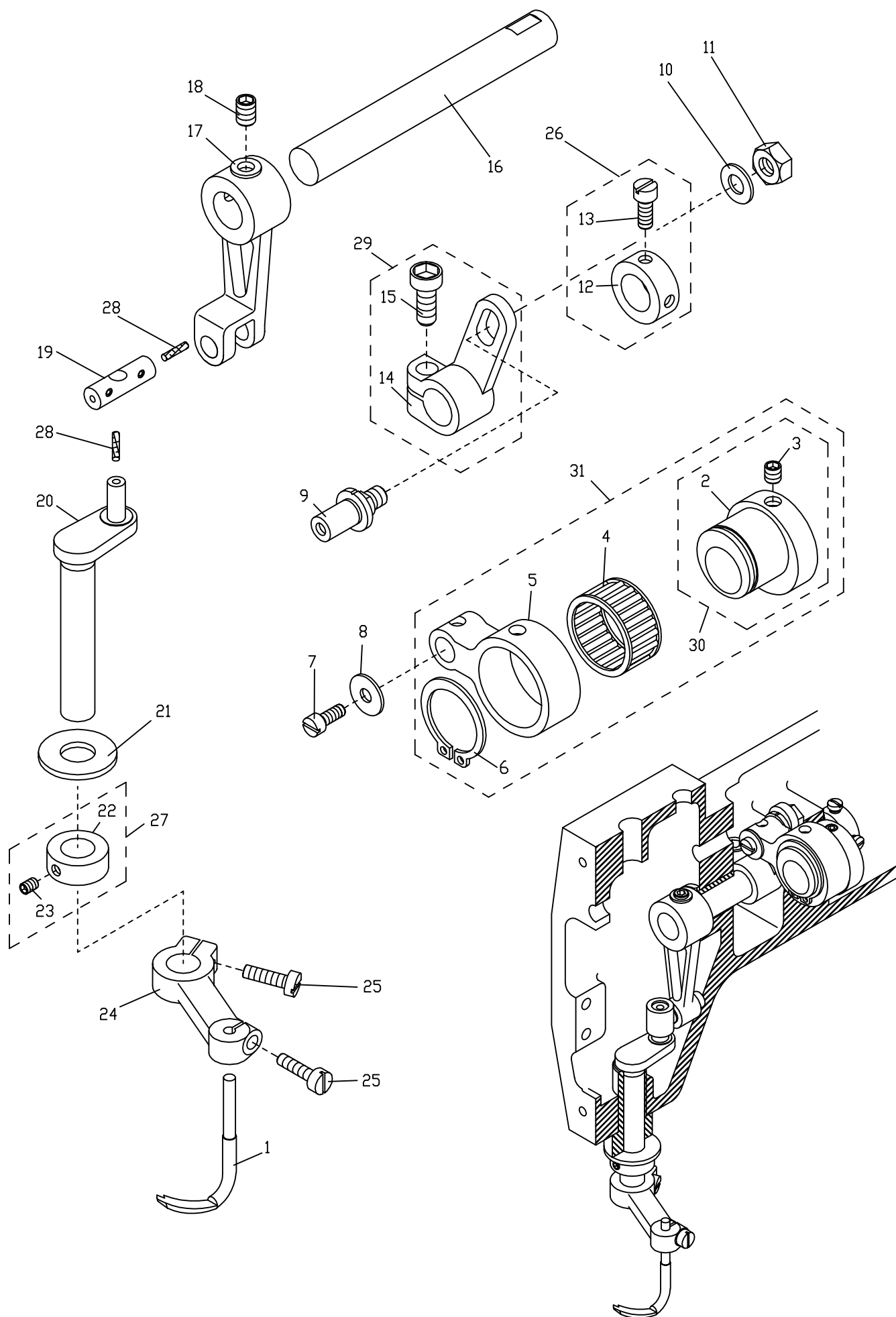

9. FT7000 / FTD7000 裝飾線驅動機構 Spreader Mechanism For FT7000 / FTD7000

序號 Ref. No.	物料編號 Parts No.	名稱 Description	單位用量 Amt.Req.
1	5221SL00560	裝飾線結線鉤 Spreader -----	1
2	2200000902	偏心輪 Eccentric -----	1
3	8MN05320500E	螺絲 Screw (CT0903 M5-0.8*5) -----	2
4	90NB222613	滾針軸承 Needle Bearing -----	1
5	2200000905	連桿 Connecting Rod -----	1
6	90SCR220	軸用C形扣環 C Ring -----	1
7	8MB04280807K	螺絲 Screw (CT0215 M4-0.7*8) -----	1
8	2200000908	墊圈 Washer -----	1
9	2200000909	曲柄銷 Rod Pin -----	1
10	2200000910	墊圈 Washer -----	1
11	8MA06400510A	螺帽 Nut (CT0533 M6-1*5) -----	1
12	2200000912	定位環 Collar -----	1
13	8MC95300606F	螺絲 Screw (CT0823 M4.5-0.75*5.5) -----	2
14	2200000914	變距曲柄 Lever -----	1
15	8MM06401610A	螺絲 Screw (CT0625 M6-1*16) -----	1
16	2200000916	軸 Shaft -----	1
17	2220000917	連桿 Connecting Rod -----	1
18	8MN06400600A	螺絲 Screw (CT0244 M6-1*6) -----	2
19	2220000919	連桿銷 Rod Pin -----	1
20	2220000920	曲軸 Crank Shaft -----	1
21	2200000921	墊圈 Washer -----	1
22	2200000922	定位環 Collar -----	1
23	8MH85240500A	螺絲 Screw (CT0923 M3.5-0.6*4.5) -----	2
24	22000009241	擺動臂 Spreader Arm -----	1
25	8MB04281207K	螺絲 Screw (CT0239 M4-0.7*12) -----	2
26	220A0000926	定位環組 Collar Asm -----	1
27	220A0000927	定位環組 Collar Asm -----	1
28	66801	油線 Oil Wick -----	2
29	222A0000929	變距曲柄 Lever -----	1
30	222A0000930	偏心輪組 Collar Asm -----	1
31	222A0000931	偏心輪組 Collar Asm -----	1

10. FT7000 / FTD7000 / FTU7011 結線鉤驅動機構 Looper Driving Mechanism

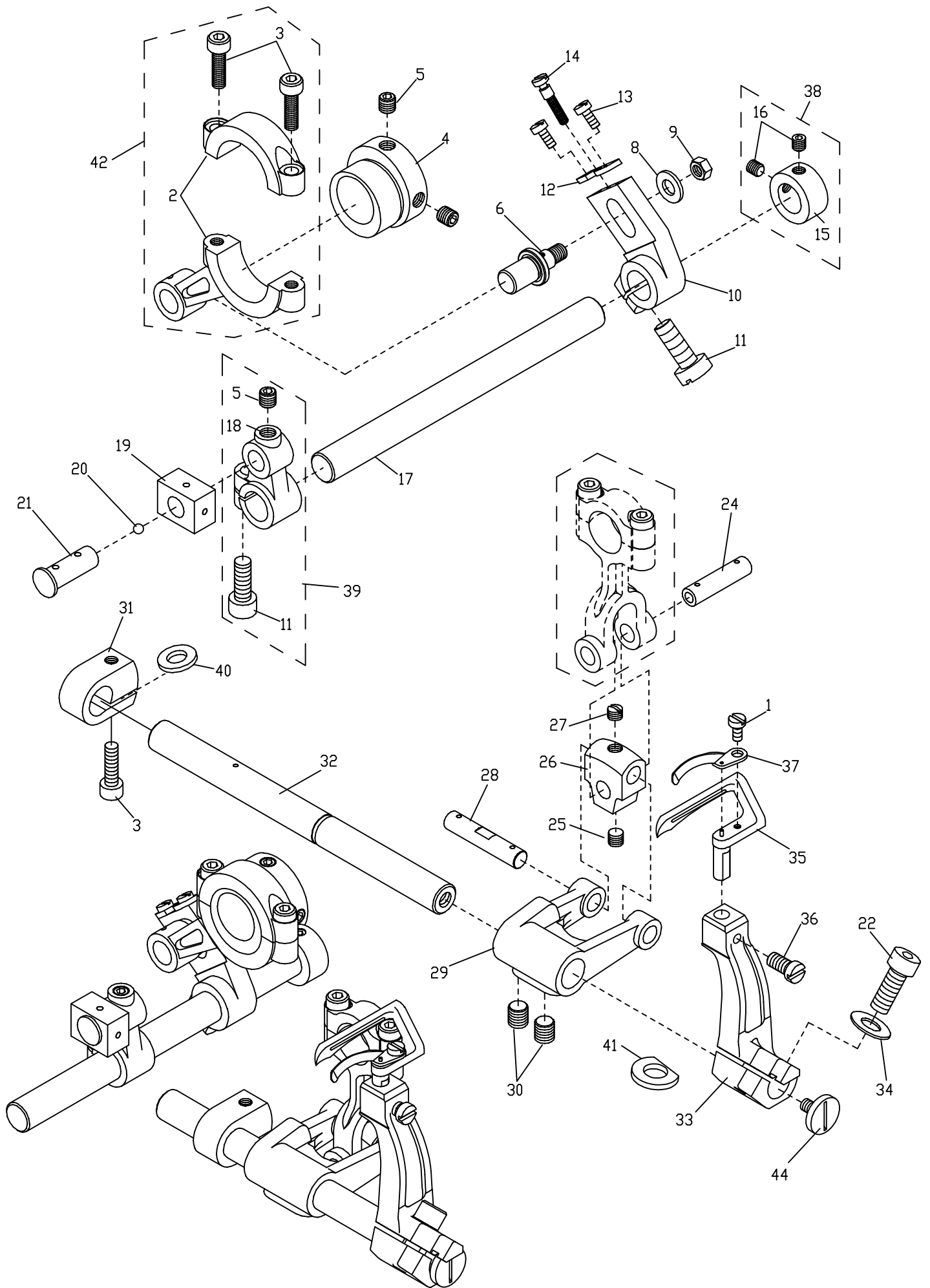

10. FT7000 / FTD7000 / FTU7011 結線鉤驅動機構 Looper Driving Mechanism

序號 Ref. No.	物料編號 Parts No.	名稱 Description	單位用量 Amt.Req.
1	8SB24560404A	螺絲 Screw (F1001) -----	1
2	2210001002	連桿 Connecting Rod -----	1
3	8MM04281407A	螺絲 Screw (FT1003 M4-0.7*14) -----	3
4	2210001004	偏心輪 Eccentric -----	1
5	8MN05320500E	螺絲 Screw (CT0903 M5-0.8*5) -----	3
6	2210001006	曲柄銷 Lever Pin -----	1
7	-----	-----	-
8	2200001025	墊圈 Washer (CT1025)-----	1
9	8MA05320408A	螺帽 Nut (CT1028 M5-0.8*4) -----	1
10	2210001010	變距曲柄 Adjusting Lever -----	1
11	8MM05321209A	螺絲 Screw (FT0524) -----	2
12	2210001012	卡樺 Adjusting Guide Plate -----	1
13	8MB75180505A	螺絲 Screw (CTS0218 M2.5-0.45*5) -----	2
14	2210001014	變距螺樁 Adjusting Stud -----	1
15	2210001015	定位環 Collar -----	1
16	8MN04280400A	螺絲 Screw (CT0229 M4-0.7*4) -----	2
17	2210001017	軸 Shaft -----	1
18	2210001018	曲柄 Lever -----	1
19	2210001019	驅動滑塊 Slide Block -----	1
20	2100000403	孔塞 Plug (SH0403) -----	1
21	2210001021	曲柄銷 Lever Pin -----	1
22	8MM05321609A	螺絲 Screw (RP101-11 M5-0.5*16) -----	1
23	-----	-----	-
24	2210001024	連結銷 Connecting Pin -----	1
25	8MN95300600A	螺絲 Screw (FT1025 M 4.5-0.75*6) -----	1
26	2210001026	十字接頭 Lever Link -----	1
27	8MH95300400A	螺絲 Screw (FT1027 M4.5-0.75*3.5) -----	1
28	2210001028	連結銷 Connecting Pin -----	1
29	2210001029	曲柄 Lever -----	1
30	8MN06400600A	螺絲 Screw (CT0244 M6-1*6) -----	2
31	2210001031	止推夾環 Collar -----	1
32	22100010321	軸 Shaft -----	1
33	22100010331	擺動臂 Rocker Arm -----	1
34	2210001034	墊圈 Washer -----	1
35	5221LL00561	下結線鉤 Looper -----	1
36	8MB04280705K	螺絲 Screw (FT1036 M4-0.7*7) -----	1
37	5221NG00561	前導針器 Needle Guide (NGF00D1) -----	1
38	221A0001038	定位環組 Collar Asm. -----	1
39	221A0001039	曲柄組 Lever Asm.-----	1
40	2100000223	墊圈 Washer (W3)-----	1
41	2210001041	墊片 Washer -----	1
42	221A0001042	連桿組 Connecting Rod Asm -----	1
43	-----	-----	-
44	8MB04280713A	螺絲 Screw (UH0427 M4-0.7*7) -----	1

11. FT7000 / FTD7000 / FTU7011 / FTK2500 進給變換機構 Feed Control Driving

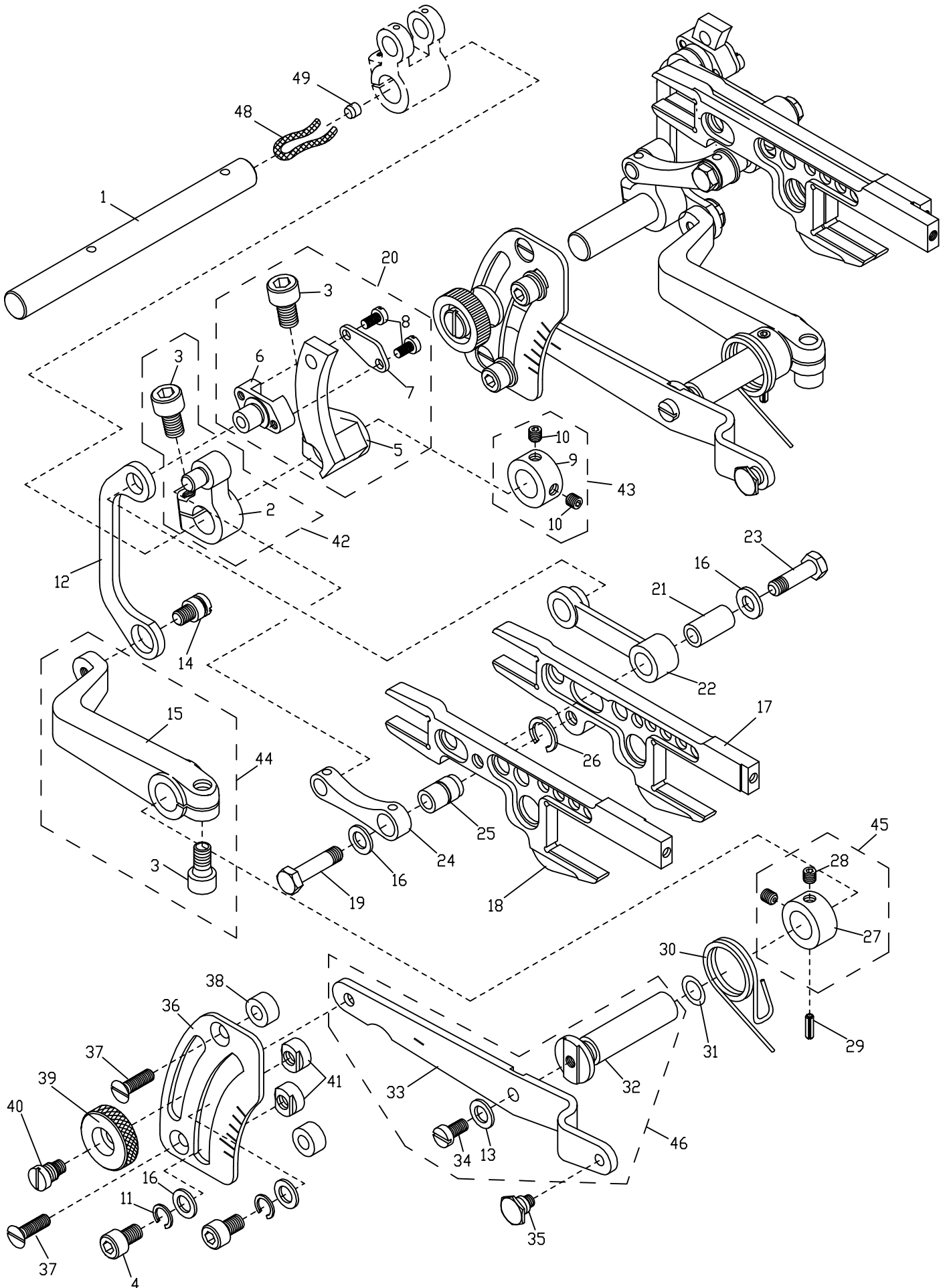

11. FT7000 / FTD7000 / FTU7011 / FTK2500 進給變換機構 Feed Control Driving

序號 Ref. No.	物料編號 Parts No.	名稱 Description	單位用量 Amt.Req.
1	22100011011	軸 Shaft -----	1
2	2210001102	曲柄 Lever -----	1
3	8MM06401210A	螺絲 Screw (FT1103 M6-1*12) -----	3
4	8MM05320809A	螺絲 Screw (CT1145 M5-0.8*8) -----	2
5	2210001105	差動變距滑道 Differential Rocker -----	1
6	2210001106	差動變距滑塊 Slide Block -----	1
7	2210001107	滑塊檔板 Slide Block Cap -----	1
8	8MB03200606K	螺絲 Screw (CT1207 M3-0.5*6) -----	2
9	2210001109	定位環 Collar -----	1
10	8MN05320500E	螺絲 Screw (CT0903 M5-0.8*5) -----	2
11	90SW050	彈簧墊圈 Spring Washer (CT0631) -----	2
12	2210001112	連桿 Link -----	1
13	2100000223	墊圈 Washer (W3)-----	1
14	2210001114	連結銷 Connecting Pin -----	1
15	2210001115	差動變換臂 Differential Lever -----	1
16	2200001025	墊圈 Washer (CT1025) -----	4
17	2210001117	主送齒驅動座 Feed Dog Seat -----	1
18	2210001118	副送齒驅動座 Feed Dog Seat -----	1
19	8MK05201808G	螺絲 Screw (FT1119 M5-0.5*18)-----	1
20	221A0001147	差動變距滑道組 Differential Rocker Asm. -----	1
21	2210001121	套管 Bushing -----	1
22	2210001122	連桿 Rod -----	1
23	8MK05202108G	螺絲 Screw (FT1123 M5-0.5*21) -----	1
24	2210001124	連桿 Rod -----	1
25	2210001125	套管 Bushing -----	1
26	2210001126	C形同心扣環 C Ring -----	1
27	2210001127	定位環 Collar -----	1
28	8MN04280400A	螺絲 Screw (CT0229 M4-0.7*4) -----	2
29	90SP0416	彈簧銷 Spring Pin (CT0820) -----	1
30	2210001130	回復彈簧 Spring -----	1
31	90OR070	O形油環 O Ring -----	1
32	2210001132	差動游標軸 Shaft -----	1
33	2210001133	差動變換桿 Lever -----	1
34	8MB04280807K	螺絲 Screw (CT0215 M4-0.7*8) -----	1
35	2210001135	懸掛螺樁 Stud -----	1
36	2210001136	差動刻記板 Regulator Plate -----	1
37	8ME04281408A	螺絲 Screw (CT1140 M4-0.7*14) -----	2
38	2200001141	隔環 Spacer (CT1141) -----	2
39	2200001147	螺帽 Nut -----	1
40	8MB06401108T	螺樁 Stud (FT71140 M6-1*11) -----	1
41	2200001142	止動環 Stopper (CT1142) -----	2
42	221A0001142	曲柄組 Lever Asm. (F1102A) -----	1
43	221A0001143	定位環組 Collar Asm. (F1109A) -----	1
44	221A0001144	差動變換臂組 Differential Lever Asm.(F1115A)-----	1
45	221A0001145	定位環組 Collar Asm. (F1127A)-----	1
46	221A0001146	差動變換桿組 Lever Set -----	1
47	-----	-----	-
48	66800	油線 Oil Wick -----	1
49	2200001029	孔塞 Plug -----	1

12. FT7000 / FTD7000 / FTU7011 導針與送布齒驅動機構 Needle Guide And Feed Dog Driving For FT7000 / FTD7000 / FTU7011

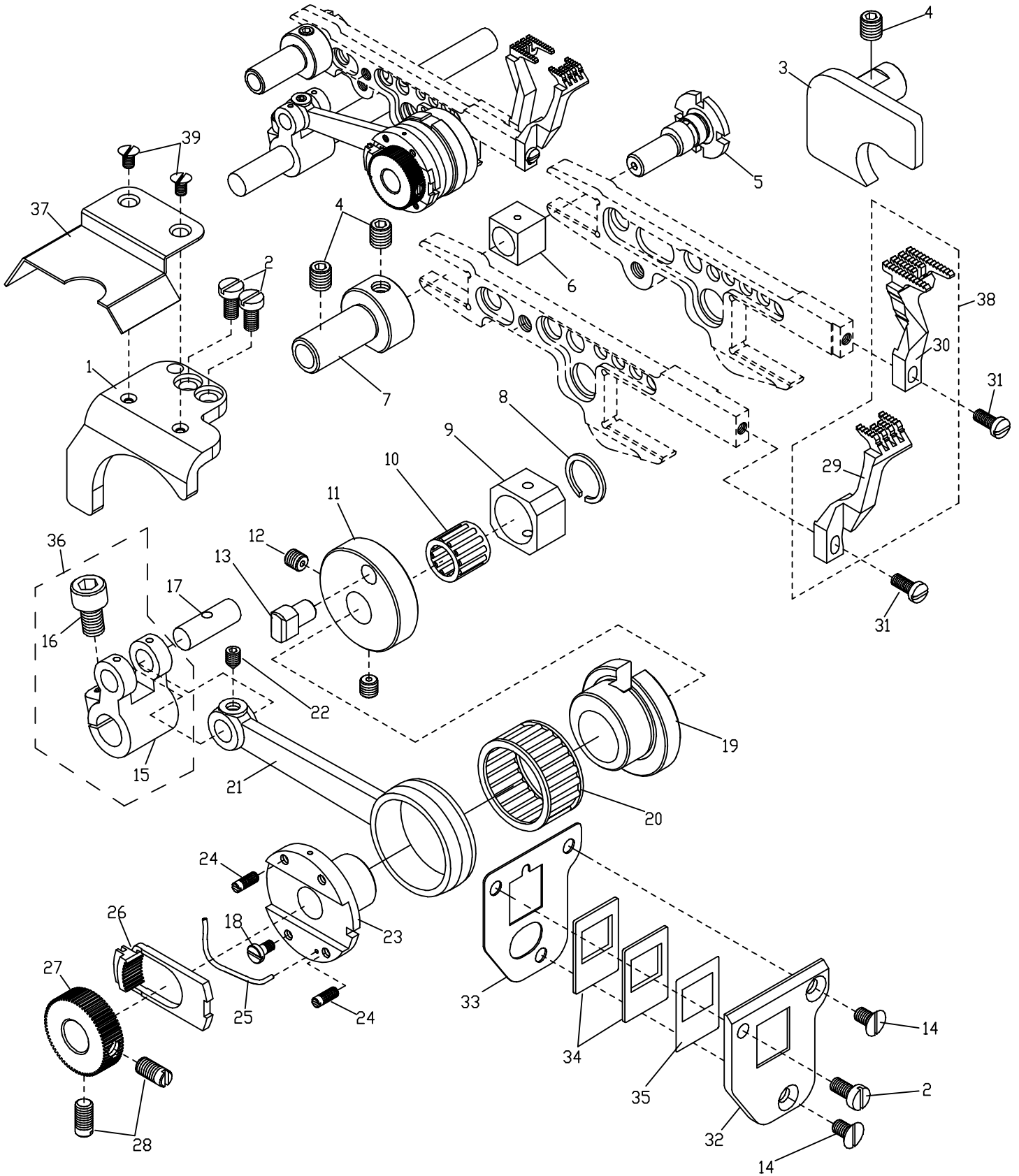

序號 Ref.No.	名稱 Description	針距 Distance Of Needles			
		4.0	4.8	5.6	6.4
30	主送布齒 Main Feed Dog	5221FD00567	5221FD00567	5221FD00567	5221FD00646
29	副送布齒 Diff Feed Dog	5221DF00563	5221DF00563	5221DF00563	5221DF00643
38	送布齒組 Feed Dog Asm.	5221DG00211	5221DG00211	5221DG00211	5221DG00221

12. FT7000 / FTD7000 / FTU7011 導針與送布齒驅動機構

Needle Guide And Feed Dog Driving For FT7000 / FTD7000 / FTU7011

序號 Ref. No.	物料編號 Parts No.	名稱 Description	單位用量 Amt.Req.
1	22100012011	送布齒座導軌 Feed Bar Guide -----	1
2	8MB04280807K	螺絲 Screw (CT0215 M4-0.7*8) -----	3
3	2210001203	送布齒座導軌 Feed Bar Guide -----	1
4	8MN06400600A	螺絲 Screw (CT0244 M6-1*6) -----	3
5	2210001205	送布齒台調整軸 Feed Adjusting Shaft-----	1
6	2200001245	滑塊 Slide Block (CT1245) -----	1
7	2210001207	懸臂 Guide -----	1
8	2210001208	C 型同心扣環 C Riing -----	1
9	2210001209	滑塊 Slide Block -----	1
10	90NB121510	滾針軸承 Needle Bearing -----	1
11	2210001211	變距銷座 Eccentric Pin Holder -----	1
12	8MN05320500E	螺絲 Screw (CT0903 M5-0.8*5)-----	2
13	2210001213	變距銷 Eccentric Pin -----	1
14	8ME04280708A	螺絲 Screw (CT0206 M4-0.7*5) -----	2
15	2210001215	曲柄 Shaft -----	1
16	8MM06401210A	螺絲 Screw (FT1103 M6-1*12) -----	1
17	2210001217	曲柄銷 Shaft Pin -----	1
18	8MB03200606B	螺絲 Screw (MT0851 M3-0.5*3) -----	1
19	2210001219	進給偏心輪 Eccentric -----	1
20	90NB242810	滾針軸承 Needle Bearing -----	1
21	2210001221	連桿 Rod -----	1
22	8MN04280500C	螺絲 Screw (FT1222 M4-0.7*5) -----	1
23	2210001223	變距偏心輪 Regulating Eccentric -----	1
24	8MB03200403F	螺絲 Screw (FT1224 M3-0.8*8) -----	2
25	2210001225	彈簧 Spring -----	1
26	22100012261	離合齒片 Regulating Plate -----	1
27	2210001227	離合齒輪 Regulating Gear -----	1
28	8MB05320805F	螺絲 Screw (FT1228 M5-0.8*8) -----	2
29	-----	副送布齒 Diff. Feed Dog (See Left Page) -----	1
30	-----	主送布齒 Main Feed Dog (See Left Page) -----	1
31	8MB85240807K	螺絲 Screw (FT0555 M3.5-0.6*8) -----	2
32	2210001232	滑動油封座 Rubber Case -----	1
33	2210001233	輔助油封座 Gasket -----	1
34	2210001234	從動式油封 Rubber -----	2
35	2210001235	墊片 Washer -----	1
36	221A0001236	曲柄組 Crank Asm. (F1215A)-----	1
37	22100012371	防油蓋 Cover -----	1
38	-----	送布齒組 Feed Dog Asm.(See Left Page) -----	1
39	8ME03200606A	螺絲 Screw (C02-35 M3-0.5*6) -----	2

13. FT7000 潤滑系統 Lubrication System For FT7000

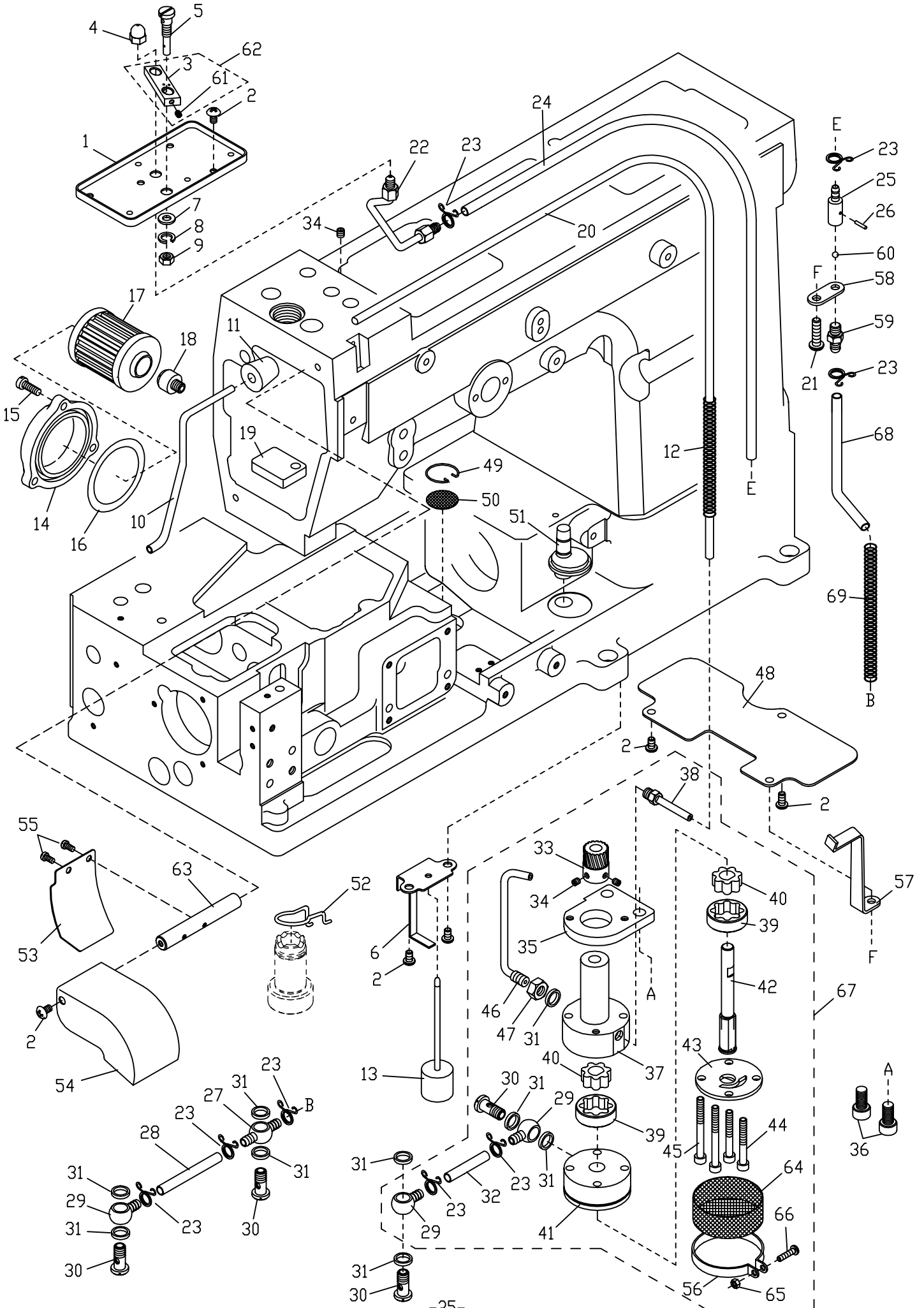

13. FT7000 潤滑系統 Lubrication System For FT7000

序號 Ref. No.	物料編號 Parts No.	名稱 Description	單位用量 Amt. Req.
1	2210001301	承油盤 Oil Receiver -----	1
2	8MC04280507D	螺絲 Screw (CT0122 M4-.7*5) -----	7
3	22100013031	導油歧路 Lubricant Guiding Block -----	1
4	2210001304	噴油嘴 Nozzle -----	1
5	2210001305	注油管 Oil Pipe -----	1
6	2210001306	浮標座 Indicator Support -----	1
7	2100000223	墊圈 Washer (W3) -----	1
8	90SW050	彈簧墊圈 Spring Washer -----	1
9	8MA05320408A	螺帽 Nut (CT1028 M5-0.8*4) -----	1
10	2210001310	油管 Oil Tube -----	1
11	2210001311	孔塞 Plug -----	1
12	22700013781	彈簧 Spring -----	1
13	2210001313	油面浮標 Indicator -----	1
14	2200001311	封蓋 Oil Filter Cover -----	1
15	8MB04281207K	螺絲 Screw (CT0239 M4-0.7*12) -----	3
16	2200001313	O形油環 O Ring -----	1
17	2100001521	過濾器 Oil Filter -----	1
18	2200001315	過濾器接頭 Oil Filter Joint -----	1
19	2200001318	羊毛氈 Felt -----	1
20	66792	油管 Oil Tube -----	1
21	8MC04281007D	螺絲 Screw (CT0113 M4-0.7*10) -----	1
22	2210001322	油管 Oil Tube -----	1
23	2100001536	夾簧 Latch Spring (SH1536) -----	8
24	66790	油管 Oil Tube -----	1
25	2220001325	單向閥 One Way Valve -----	1
26	2220001331	銷 Pin -----	1
27	2200001327	油管接頭 Oil Tube Joint -----	1
28	2200001328	油管 Oil Tube -----	1
29	2100001535	油管接頭 Oil Tube Joint (SH1535) -----	3
30	2100001533	螺樁 Stud -----	4
31	2100001534	油封 Seal -----	9
32	2200001332	油管 Oil Tube -----	1
33	2200001341	蝸母 Worm Gear -----	1
34	8MN04280400A	螺絲 Screw (CT0229 M4-0.7*40) -----	3
35	2200001352	泵座 Pump Seat -----	1
36	8MM06401210A	螺絲 Screw (FT1103 M6-1*12) -----	2
37	2200001353	回收泵 Pump Body -----	1
38	2200001344	油管 Oil Tube -----	1
39	2200001354	外轉子 Outside Rotor -----	2
40	2200001355	內轉子 Inside Rotor -----	2
41	2200001356	壓出泵 Rotor Case -----	1
42	2200001357	軸 Shaft -----	1
43	2200001358	封蓋 Cover -----	1
44	8MM04283007B	螺絲 Screw (CT1359 M4-0.7*30) -----	2
45	8MM04284007B	螺絲 Screw (CT1310 M4-0.7*40) -----	2
46	2200001346	噴油嘴 Nozzle -----	1
47	8MA06400510A	螺帽 Nut (CT0533 M6-1*5) -----	1
48	2210001348	隔板 Separate -----	1
49	2200001316	扣簧 Filter Screen Clamp -----	1
50	2200001317	網板 Filter Screen -----	1
51	2210001351	油面計 Oil Wick -----	1
52	2270001352	壓簧 Spring Latch -----	1
53	2210001353	防油蓋 Cover -----	1
54	2210001354	防油蓋 Cover -----	1
55	8MB03200506K	螺絲 Screw (CT0525 M3-0.5*5) -----	2
56	2220001369	夾簧 Latch Spring -----	1
57	2200001348	油管支撐臂 Oil Tube Holder -----	1
58	2220001339	止回閥座 Bracket -----	1
59	2220001340	油嘴 Oil Tube Joint -----	1
60	2220001349	鋼珠 Steel ball -----	1
61	8SG24560300A	螺絲 Screw (F600130 3/32"-56) -----	1
62	221A0001362	導油歧路組 Lubricant Guiding Block Asm. -----	1
63	2210001352	軸 Shaft -----	1
64	2220001368	油網 Oil Mesh -----	1
65	8MA03200306A	螺帽 Nut(FTB0111 M3-0.5*3) -----	1
66	8MC03201306D	螺絲 Screw (UTB0335 M3-0.5*12.5) -----	1
67	220A0001367	泵組 Pump Asm. -----	1
68	66790	油管 Oil Tube -----	1
69	2270001377	彈簧 Spring -----	1

14. 66707 線架 Thread Stand For 66707

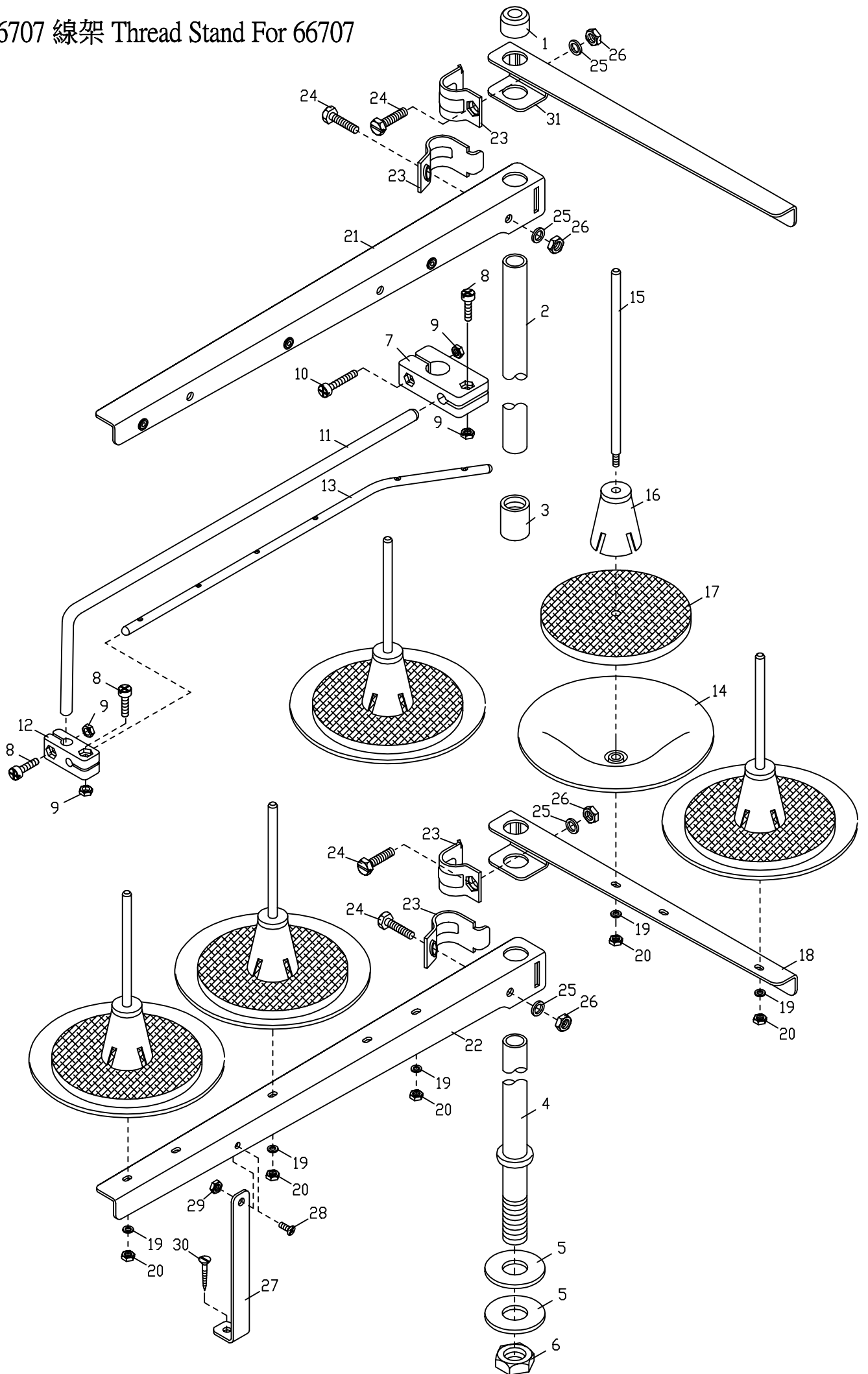

14. 66707 線架 Thread Stand For 66707

序號 Ref. No.	物料編號 Parts No.	名稱 Description	單位用量 Amt. Req.
1	667051	柱帽 Rod Cup -----	1
2	667052	上柱 Upper Thread Stand Rod -----	1
3	667053	接頭 Joint -----	1
4	667054	下柱 Lower Thread Stand Rod -----	1
5	667055	墊圈 Washer -----	2
6	667056	螺帽 Nut -----	1
7	667057	接頭 Bracket -----	1
8	667058	螺絲 Screw -----	3
9	667059	螺帽 Nut -----	4
10	6670510	螺絲 Screw -----	1
11	6670511	旋臂 Arm -----	1
12	6670512	接頭 Bracket -----	1
13	6670513	導線桿 Thread Guide -----	1
14	6670514	線盤 Spool Set for SH6005 -----	5
15	6670515	線盤軸 Spool Pin -----	5
16	6670516	定心錐 Spool Retaining Fig -----	5
17	6670517	緩衝墊 Seat -----	5
18	667061	線盤座 Spool Set Bracket -----	1
19	6670519	彈簧墊圈 Spring Washer -----	5
20	6670520	螺帽 Nut -----	5
21	6670521	導線臂 Thread Guide -----	1
22	6670522	線盤座 Spool Set Bracket -----	1
23	6670523	夾板 Clamp -----	4
24	6670524	螺絲 Screw -----	4
25	6670525	彈簧墊圈 Spring Washer -----	4
26	6670526	螺帽 Nut -----	4
27	6670527	撐桿 Support Rod -----	1
28	6670528	螺絲 Screw -----	1
29	6670529	螺帽 Nut -----	1
30	6670530	木螺絲 Wood Screw -----	1
31	6670531	導線 Thread Guide -----	1

15. FT7000 裝載附件 Supporting Board For FT7000

半沉式

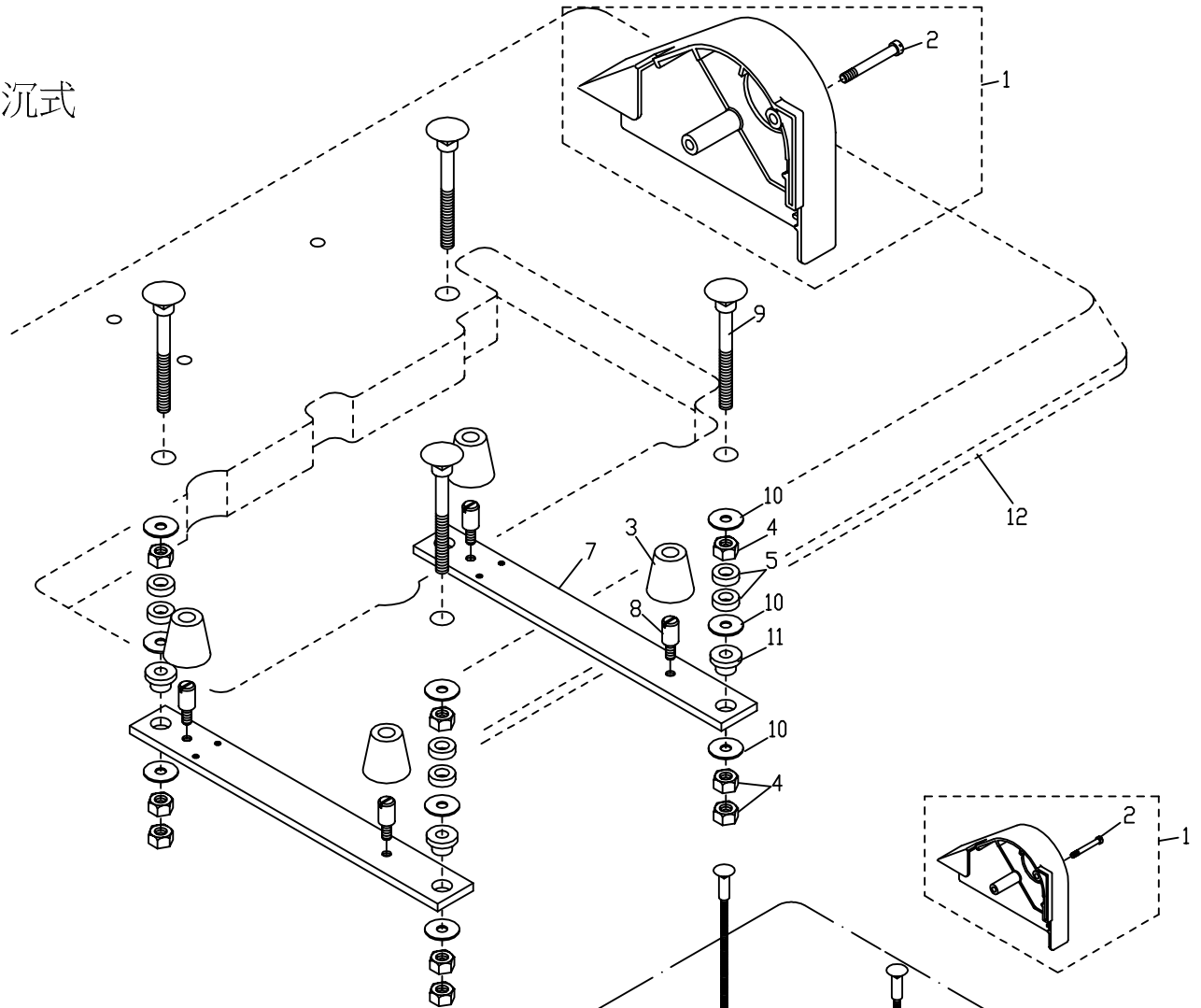

全沉式

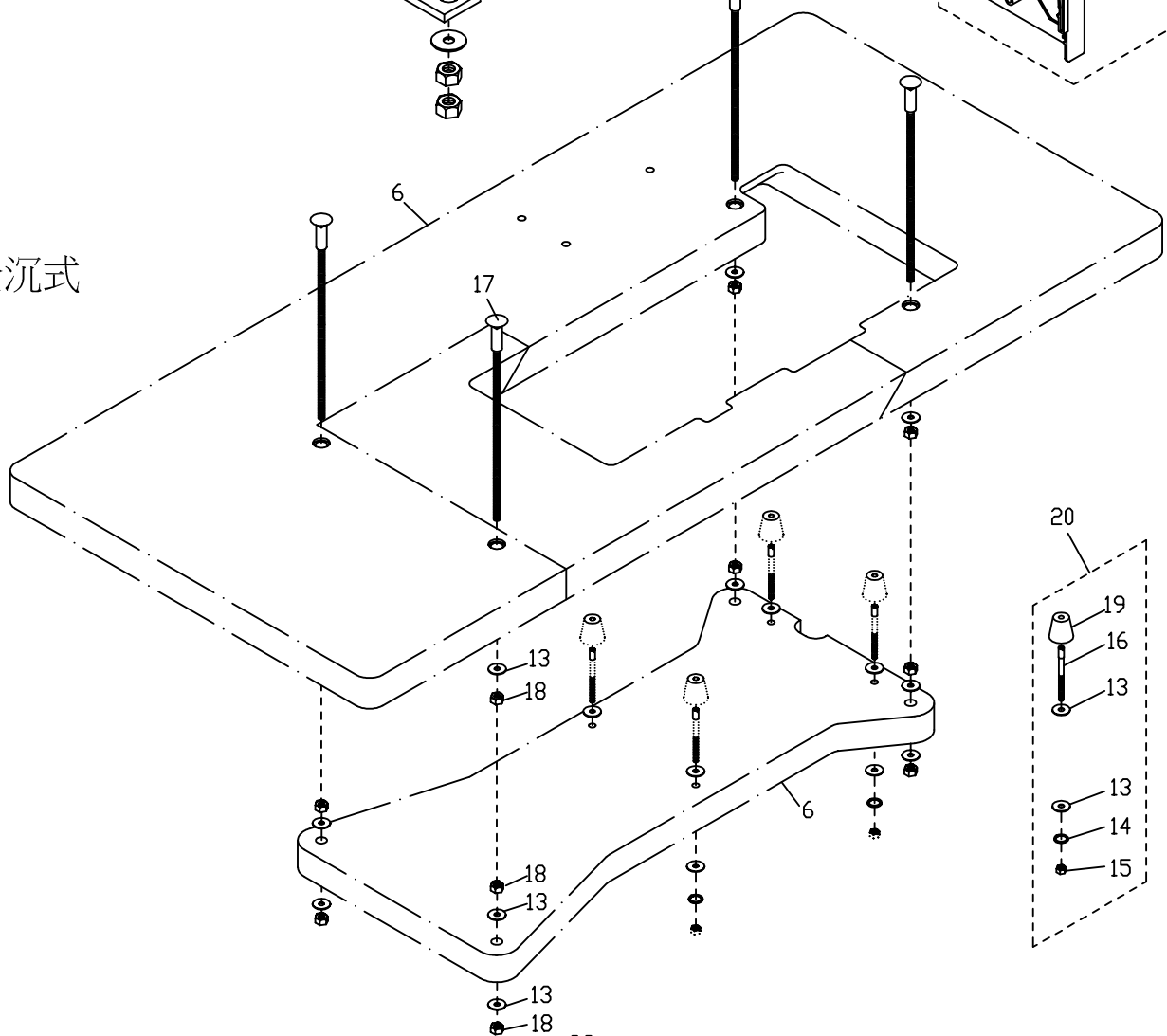

15. FT7000 裝載附件 Supporting Board For FT7000

序號 Ref. No.	物料編號 Parts No.	名稱 Description	單位用量 Amt.Req.
1	2200001501	皮帶蓋 Belt Cover -----	1
2	8MB06404609S	螺絲 Screw (CT1502 M6-1*46) -----	2
3	66945	減震橡膠 Rubber Cushion -----	4
4	8SA79180613A	螺帽 Nut (CT1514 5/16"-18*6) -----	12
5	2210001505	隔環 Spacer -----	8
6	66812-2	全沉式車板 Table -----	1
7	2210001507	車頭承板 Supporting Board -----	2
8	8MB06401012M	螺椿 Bolt (FT1508 M6-1*10) -----	4
9	8SC79189627B	懸吊螺椿 Bolt (FT1509 5/16"-18*96) -----	4
10	2200001510	墊圈 Washer -----	12
11	2200001511	橡膠環 Rubber Washer -----	4
12	66812-1	車板 Table -----	1
13	2200001504	墊圈 Washer -----	20
14	90SW070	彈簧墊圈 Spring Wahsher -----	4
15	8MA06400612A	螺帽 Nut (SH0242 M6-1*6) -----	4
16	8MB06406507B	螺椿 Bolt (CT1507 M6-1*65) -----	4
17	2210001608	螺椿 Bolt -----	4
18	8MA08500613A	螺帽 Nut (RP0208 M8-1.25) -----	12
19	66943	減震橡膠 Rubber Cushion -----	4
*20	221A0001520	全沉式車板螺絲組 Screws Set For Fully Sub-Merged Type Table -----	1

* 全沉式車板需附加此組螺絲組件

16. FT7000 工具及附件 Accesseries For FT7000

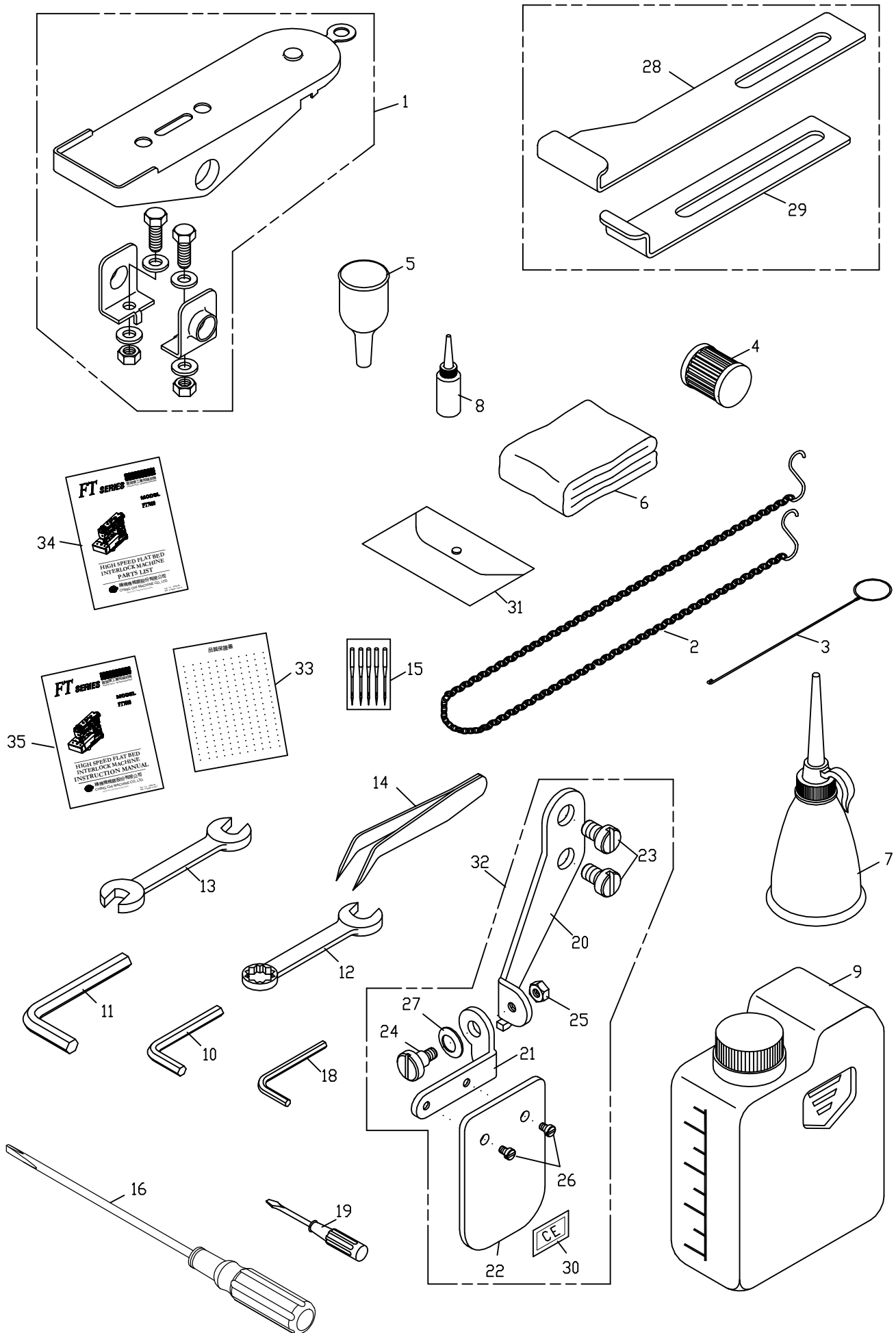

16. FT7000 工具及附件 Accesseries For FT7000

序號 Ref. No.	物料編號 Parts No.	名稱 Description	單位用量 Amt.Req.
1	66700	踏板組 Pedel Complete -----	1
2	66695	鍊條組 Chain Set -----	1
3	66840	穿線鋼絲 Threading Bar -----	1
4	2100001521	過濾器 Oil Filter -----	1
5	66722	漏斗 Oil Funnel -----	1
6	66846	防塵罩 Mechine Cover -----	1
7	66721	油壺 Oiler -----	1
8	66720	油壺 Oiler -----	1
9	66715	油罐 Oil Container -----	1
10	66636	六角扳手 Spanner 3MM -----	1
11	66637	六角扳手 Spanner 4MM -----	1
12	66612	梅花扳手 Wrench 10MM -----	1
13	66613	開口扳手 Wrench 7/8MM -----	1
14	66690	鑷子 Tweezer -----	1
15	66725-11-5	備用針 Retainer Needle -----	1
16	66671	木柄一字起子 Wooden Handle Flat Screw Driver -----	1
17	-----	-----	-
18	66639	六角扳手 Spanner 1.5MM -----	1
19	66667	小起子 Screw Driver (Small) -----	1
20	2200001620	護目鏡座 Safety Plate Support -----	1
21	2200001621	護目鏡架 Safety Plate Holder -----	1
22	2200001622	護目鏡 Safety Plate -----	1
23	8MC06401008E	螺絲 Screw (CT0832 M6-1*9.5) -----	2
24	8SB36400810E	螺絲 Screw (CT1624 9/64"-40*7.7) -----	1
25	8SA36400306A	螺帽 Nut (K09-09 9/64"-40*3) -----	1
26	8MB03200405A	螺絲 Screw (FT0548 M3-0.5*4) -----	2
27	2200000228	墊圈 Washer -----	1
28	66857	左導模 Fabric Guide (L) -----	1
29	66858	右導模 Fabric Guide (R) -----	1
30	66451	貼紙 Paster -----	1
31	66831	工具袋 Tools Bag -----	1
32	220A0001632	護目鏡組 Safety Plate Asm.-----	1
33	66200	保證書 Guarautee -----	1
34	FT6301-1G-06-10	零件冊 Parts List-----	1
35	FT62M1-1-06-10	使用說明書 Instruction Manual-----	1

FT7000-0-0□□□M
FT7000-0-□□□M

FT7000 GAUGE PARTS LIST

Main Parts 更換零件 針距 Needle m.m	Throat plate 針板	Presser foot asm 壓腳	Main feed dog 主送布齒	Diff feed dog 副送布齒	Needle clamp 針留	Upper looper 上結線鉤	Lower looper 下結線鉤	Needle guide 前導針	Needle guide 後導針	Needle 針
2	4.0	5222TP00401	5220PF00404	5221FD00567	5221DF00563	5220NC00400	5221SL00560	5221LL00561	5221NG00561	5221NG00562
2	4.8	5220TP00484	5220PF00484	5221FD00567	5221DF00563	5220NC00480	5221SL00560	5221LL00561	5221NG00561	5221NG00562
3	4.8	5220TP00484	5220PF00485	5221FD00567	5221DF00563	5220NC00485	5221SL00560	5221LL00561	5221NG00561	5221NG00562
3	5.6	5220TP00564	5220PF00564	5221FD00567	5221DF00563	5227NC00560	5221SL00560	5221LL00561	5221NG00561	5221NG00562
3	6.4	5220TP00642	5220PF00644	5221FD00646	5221DF00643	5227NC00640	5221SL00560	5221LL00561	5221NG00561	5221NG00562

UY128GAS
11







FT7000-0-0□□□H
FT7000-0-□□□H

Main Parts 更換零件 針距 Needle m.m	Throat plate 針板	Presser foot asm 壓腳	Main feed dog 主送布齒	Diff feed dog 副送布齒	Needle clamp 針留	Upper looper 上結線鉤	Lower looper 下結線鉤	Needle guide 前導針	Needle guide 後導針	Needle 針
2	4.0	5222TP00400	5220PF00404	5221FD00567	5221DF00563	5220NC00400	5221SL00560	5221LL00561	5221NG00561	5221NG00562
2	4.8	5222TP00480	5220PF00484	5221FD00567	5221DF00563	5220NC00480	5221SL00560	5221LL00561	5221NG00561	5221NG00562
3	4.8	5222TP00480	5220PF00485	5221FD00567	5221DF00563	5220NC00485	5221SL00560	5221LL00561	5221NG00561	5221NG00562
3	5.6	5220TP00566	5220PF00564	5221FD00567	5221DF00563	5227NC00560	5221SL00560	5221LL00561	5221NG00561	5221NG00562
3	6.4	5220TP00644	5220PF00644	5221FD00646	5221DF00643	5227NC00640	5221SL00560	5221LL00561	5221NG00561	5221NG00562

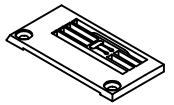
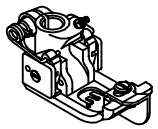

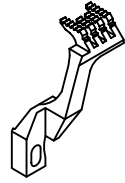
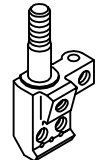
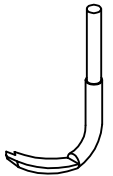
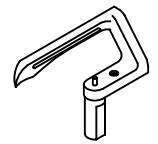

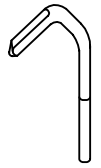

UY128GAS
14

FT7000-0-0□□□W
 FT7000-0-□□□W

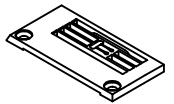
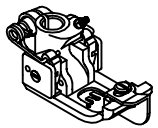
FT7000 GAUGE PARTS LIST

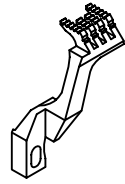
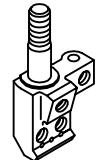
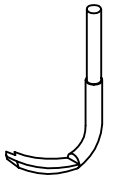
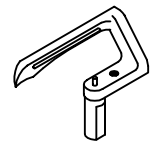

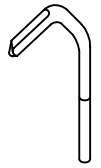



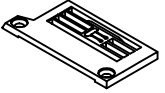

Main Parts 更換零件 針距 Needle m.m											
											Throat plate 針板
3	5.6	5220TP00568	5220PF00564	5221FD00567	5221DF00563	5227NC00560	5221SL00560	5221LL00561	5221NG00561	5221NG00562	UY128GAS # 11
				5221DG00211							
3	6.4	5220TP00646	5220PF00644	5221FD00646	5221DF00643	5227NC00640	5221SL00560	5221LL00561	5221NG00561	5221NG00562	
				5221DG00221							

FT7000-0-0□□□L
 FT7000-0-□□□L

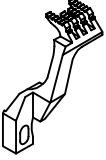
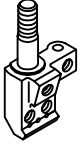
Main Parts 更換零件 針距 Needle m.m											
											Throat plate 針板
2	4.0	5222TP00402	5220PF00404	5221FD00567	5221DF00563	5220NC00400	5221SL00560	5221LL00561	5221NG00561	5221NG00562	UY128GAS # 11
				5221DG00211							
2	4.8	5222TP00481	5220PF00484	5221FD00567	5221DF00563	5220NC00480	5221SL00560	5221LL00561	5221NG00561	5221NG00562	
				5221DG00211							
3	4.8	5222TP00481	5220PF00485	5221FD00567	5221DF00563	5220NC00485	5221SL00560	5221LL00561	5221NG00561	5221NG00562	
				5221DG00211							
3	5.6	5222TP00560	5220PF00564	5221FD00567	5221DF00563	5227NC00560	5221SL00560	5221LL00561	5221NG00561	5221NG00562	
				5221DG00211							
3	6.4	5222TP00640	5220PF00644	5221FD00646	5221DF00643	5227NC00640	5221SL00560	5221LL00561	5221NG00561	5221NG00562	
				5221DG00221							



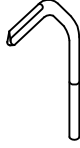



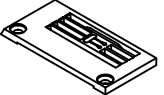
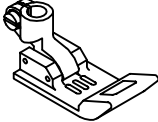

FT7000 GAUGE PARTS LIST

FT7000-0-□□□M/KI002

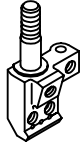
Main Parts 更換零件											Needle 針	Needle 針	Needle 針
*	3	5.6	5222TP00569	5220PF00564	5221FD00567	5221DG00211	5221DF00563	5227NC00560	5221SL00560	5221LL00561	5221NG00561	5221NG00562	UY128GAS
*	3	6.4	5222TP00647	5220PF00644	5221FD00646	5221DG00221	5221DF00643	5227NC00640	5221SL00560	5221LL00561	5221NG00561	5221NG00562	# 11



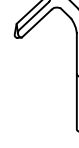



*OPTION-MAKE TO ORDER

FT7000-0-02□□M/TB

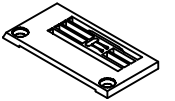
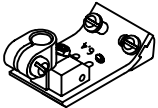

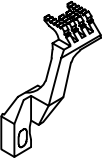
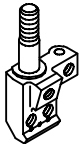
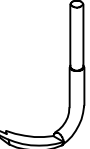
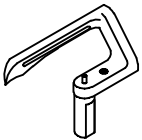

Main Parts 更換零件											Needle 針	Needle 針	Needle 針
	3	5.6	5220TP00564	5221PFTB0560	5221FD00567	5221DG00211	5221DF00563	5227NC00560	5221SL00560	5221LL00561	5221NG00561	5221NG00562	UY128GAS
	3	6.4	5220TP00642	5221PFTB0640	5221FD00646	5221DG00221	5221DF00563	5227NC00640	5221SL00560	5221LL00561	5221NG00561	5221NG00562	# 11

FT7000 GAUGE PARTS LIST

FT7000-0-02□□M/TB003

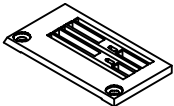
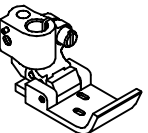

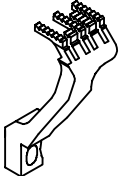
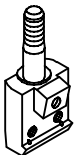
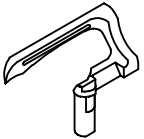
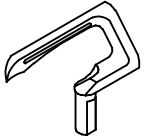

Main Parts 更換零件											Needle 針	針	針
												數	針
3	5.6	5220TP00564	5221PFTB3560	5221FD00567	5221DF00563	5227NC00560	5221SL00560	5221LL00561	5221NG00561	5221NG00562	UY128GAS # 11		
				5221DG00211									
3	6.4	5220TP00642	5221PFTB3640	5221FD00646	5221DF00563	5227NC00640	5221SL00560	5221LL00561	5221NG00561	5221NG00562			
				5221DG00221									

FT7002-0-2□□M

Main Parts 更換零件										Needle 針	針	針
											數	針
2	4.8	5221TP02480	5221PF02480	5221FD02480	5221DF02480	5221NC02480	5221LL02641	5221LL02640	5221NG02640	UY128GAS #11		
				5221DG0029								
2	6.4	5221TP02640	5221PF02640	5221FD02640	5221DF02640	5221NC02640	5221LL02641	5221LL02640	5221NG02640	UY128GAS #11		
				5221DG0003								

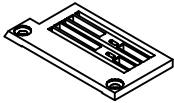
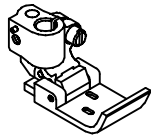
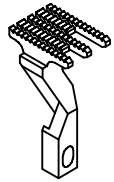
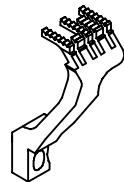
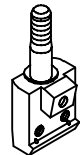

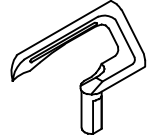

FT7000 GAUGE PARTS LIST

FT7002-0-2□□48M/KI002

Main Parts 更換零件 針距 Needle m.m										
										Throat plate 針板
2	4.8	5221TP02481	5221PF02480	5221FD02480	5221DF02480	5221NC02480	5221LL02641	5221LL02640	5221NG02640	UY128GAS#11
				5221DG0029						

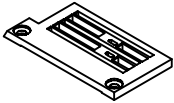
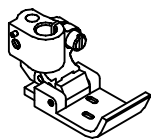
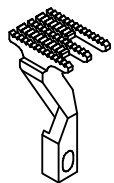
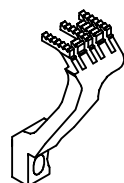
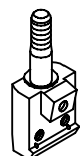

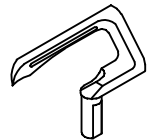



-37-

FT7002-0-2□□M/TC□08

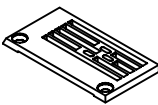
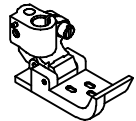

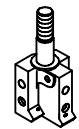

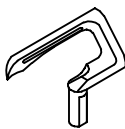

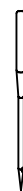
Main Parts 更換零件 針距 Needle m.m										
										Throat plate 針板
2	6.4	5221TP02642	5221PF02640	5221FD02640	5221DF02640	5221NC02640	5221LL02641	5221LL02640	5221NG02640	UY128GAS#11
				5221DG0003						

FT7000 GAUGE PARTS LIST

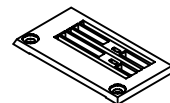
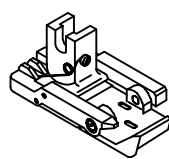
FT7002-1-364M

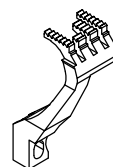
Main Parts 更換零件 針距 Needle m.m											
	Throat plate 針板	Presser foot asm 壓腳	Main feed dog 主送布齒	Diff feed dog 副送布齒	Needle clamp 針留	Lower looper (Right) 下結線鉤(右)	Lower looper (Medium) 下結線鉤(中)	Lower looper (Left) 下結線鉤(左)	Needle guide 後導針	Needle 針	
3	6.4	5221TP02641	5221PF02641	5221FD02641 5221DG0004	5221DF02641	5221NC02641	5221LL02641	5221LL02642	5221LL02643	5221NG02641	UY128GAS #11

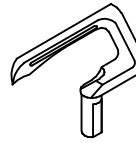
FT7002-A-248M

Main Parts 更換零件 針距 Needle m.m										
	Throat plate 針板	Presser foot asm 壓腳	Main feed dog 主送布齒	Diff feed dog 副送布齒	Needle clamp 針留	Lower looper (Right) 下結線鉤(右)	Lower looper (Left) 下結線鉤(左)	Needle guide 後導針	Needle 針	
2	4.8	5221TP02480	5221PF02481	5221FD02480 5221DG0029	5221DF02480	5221NC02481	5221LL02641	5221LL02640	5221NG02640	UY128GAS #11

FT7000 GAUGE PARTS LIST

FT7002-A-248M/KI002

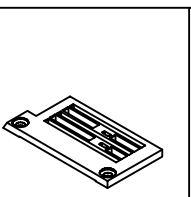
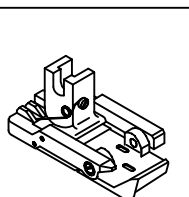
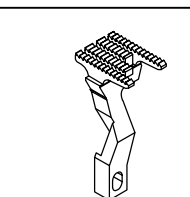
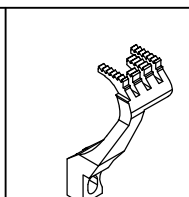
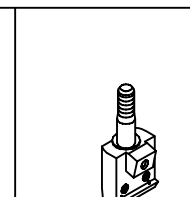
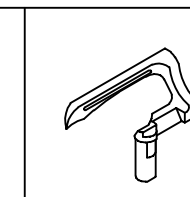
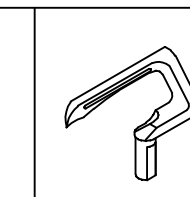
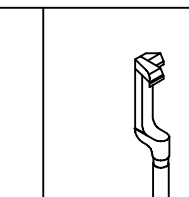
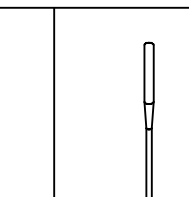
Main Parts 更換零件 針距 Needle 數 m.m										
										Throat plate 針板
2	4.8	5221TP02480	5221PF02481	5221FD02480 5221DG0029	5221DF02480	5221NC02481	5221LL02641	5221LL02640	5221NG02640	UY128GAS#11

-39-

FT7003-0-0□□□M

FT7003-0-□□□M

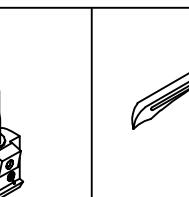
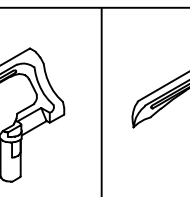
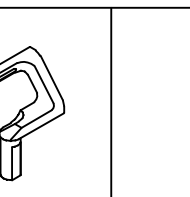
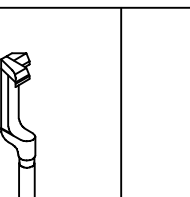
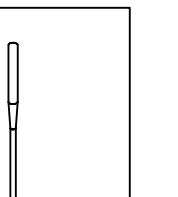
Main Parts 更換零件 針距 Needle 數 m.m										
2	3.2	5222TP03321	5222PF03321	5222FD03562 5222DG00011	5222DF03563	5222NC15320				
2	4.0	5222TP03401	5222PF03401	5222FD03562 5222DG00011	5222DF03563	5222NC00400				
3	4.8	5222TP03482	5222PF03482	5222FD03562 5222DG00011	5222DF03563	5222NC00485	5221SL00560	5221LL00561	5221NG00561	5221NG00562
3	5.6	5222TP03561	5222PF03561	5222FD03562 5222DG00011	5222DF03563	5227NC00560				
3	6.4	5222TP03641	5222PF03641	5222FD03562 5222DG00011	5222DF03563	5227NC00640				UY128GAS # 11

FT7000 GAUGE PARTS LIST

FT7003-0-□□□M / TC□03







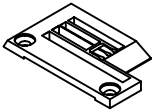
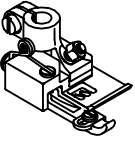

Main Parts 更換零件 針距 Needle m.m	Throat plate 針板	Presser foot asm 壓腳	Main feed dog 主送布齒	Diff feed dog 副送布齒	Needle clamp 針留	Upper looper 上結線鉤	Lower looper 下結線鉤	Needle guide 前導針	Needle guide 後導針	Needle 針	
											5221TP03562
3	5.6	5221TP03562	5221PF03561	5221FD03566	5221DF03563	5227NC00560	5221SL00560	5221LL00561	5221NG00561	5221NG00562	UY128GAS # 11
3	6.4	5221TP03642	5221PF03641	5221FD03566	5221DF03563	5227NC00640	5221SL00560	5221LL00561	5221NG00561	5221NG00562	UY128GAS # 11

FT7003-0-□□□M / TC□09

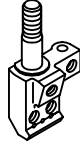
Main Parts 更換零件 針距 Needle m.m	Throat plate 針板	Presser foot asm 壓腳	Main feed dog 主送布齒	Diff feed dog 副送布齒	Needle clamp 針留	Upper looper 上結線鉤	Lower looper 下結線鉤	Needle guide 前導針	Needle guide 後導針	Needle 針	
											5221TP03323
2	3.2	5221TP03323	5222PF03321	5223FD03562	5221DF03563	5221NC15320	5221SL00560	5221LL00561	5221NG00561	5221NG00562	UY128GAS # 11
2	4.0	5221TP03403	5222PF03401	5223FD03562	5221DF03563	5220NC00400	5221SL00560	5221LL00561	5221NG00561	5221NG00562	
3	4.8	5221TP03483	5222PF03482	5223FD03562	5221DF03563	5220NC00485	5221SL00560	5221LL00561	5221NG00561	5221NG00562	
3	5.6	5221TP03563	5222PF03561	5223FD03562	5221DF03563	5227NC00560	5221SL00560	5221LL00561	5221NG00561	5221NG00562	
3	6.4	5221TP03643	5222PF03641	5223FD03562	5221DF03563	5227NC00640	5221SL00560	5221LL00561	5221NG00561	5221NG00562	







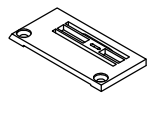
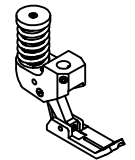

FT7000 GAUGE PARTS LIST

FT7003-1-0□□□M
FT7003-1-□□□M

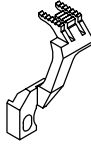
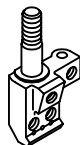
Main Parts 更換零件 針距 Needle m.m										
2	3.2	5222TP03321	5222PF03321	5223FD03563	5223DF03561	5221NC15320				
				5223DG00021						
2	4.0	5222TP03401	5222PF03401	5223FD03563	5223DF03561	5220NC00400				
				5223DG00021						
3	4.8	5222TP03482	5222PF03482	5223FD03563	5223DF03561	5220NC00485	5221SL00560	5221LL00561	5221NG00561	5221NG00562
				5223DG00021						
3	5.6	5222TP03561	5222PF03561	5223FD03563	5223DF03561	5227NC00560				
				5223DG00021						
3	6.4	5222TP03641	5222PF03641	5223FD03563	5223DF03561	5227NC00640				
				5223DG00021						



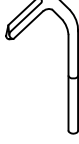



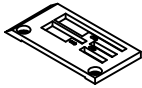
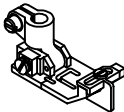
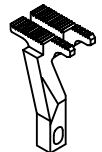

-41-

FT7008-2-0100M

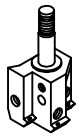
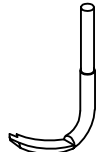
Main Parts 更換零件 針距 Needle m.m											
											Throat plate 針板
1	-	5228TP08000	5228PF08000	5228FD08001	5228DF08000	5227NC00560	5221SL00560	5221LL00561	5221NG00561	5221NG00562	UY128GAS #11
				5228DG00031							

FT7000 GAUGE PARTS LIST

FT7010-0-388M

Main Parts 更換零件 針距 Needle m.m												
	Throat plate 針板	Presser foot asm 壓腳	Main feed dog 主送布齒	Diff feed dog 副送布齒	Needle clamp 針留	Upper looper 上結線鉤	Lower looper (Right) 下結線鉤(右)	Lower looper (Medium) 下結線鉤(中)	Lower looper (Left) 下結線鉤(左)	Needle guide 後導針	Needle 針	
3	8.8	5221TP10880	5221PF10880	5221FD10880 5221DG007	5221DF10880	5221NC10880	5221SL10560	5221LL02641	5221LL02640	5221LL10880	5221NG10880	UY128GAS #11

-42-

FT7010-0-388M/KI002

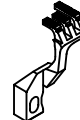



Main Parts 更換零件 針距 Needle m.m												
	Throat plate 針板	Presser foot asm 壓腳	Main feed dog 主送布齒	Diff feed dog 副送布齒	Needle clamp 針留	Upper looper 上結線鉤	Lower looper (Right) 下結線鉤(右)	Lower looper (Medium) 下結線鉤(中)	Lower looper (Left) 下結線鉤(左)	Needle guide 後導針	Needle 針	
3	8.8	5221TP10881	5221PF10880	5221FD10880 5221DG007	5221DF10880	5221NC10880	5221SL10560	5221LL02641	5221LL02640	5221LL10880	5221NG10880	UY128GAS #11

*

*OPTION-MAKE TO ORDER

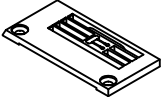
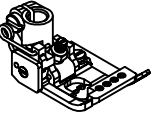

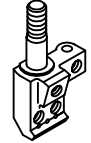
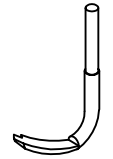
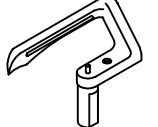

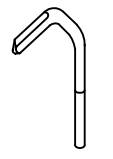
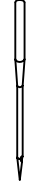

FT7000 GAUGE PARTS LIST

FT7011-0-0□□□M
FT7011-0-□□□M

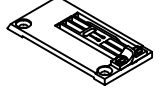
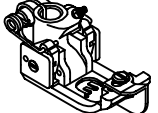
Main Parts 更換零件 針數 Needle	針距 m.m	 Throat plate 針板	 Presser foot asm 壓腳	 Main feed dog 主送布齒	 Diff feed dog 副送布齒	 Needle clamp 針留	 Upper looper 上結線鉤	 Lower looper 下結線鉤	 Needle guide 前導針	 Needle guide 後導針	 Needle 針
2	4.0	5222TP00401	5222PF11400	5221FD00567	5221DF00563	5220NC00400	5221SL00560	5221LL00561	5221NG00561	5221NG00562	UY128GAS # 11
2	4.8	5220TP00484	5222PF11480	5221FD00567	5221DF00563	5220NC00480	5221SL00560	5221LL00561	5221NG00561	5221NG00562	
3	5.6	5220TP00564	5222PF11560	5221FD00567	5221DF00563	5227NC00560	5221SL00560	5221LL00561	5221NG00561	5221NG00562	
3	6.4	5220TP00642	5222PF11640	5221FD00646	5221DF00643	5227NC00640	5221SL00560	5221LL00561	5221NG00561	5221NG00562	

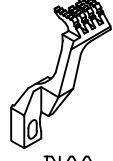
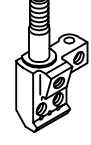
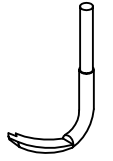
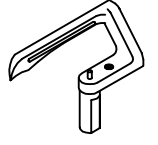

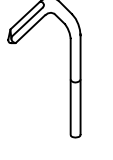



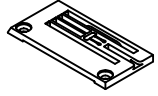
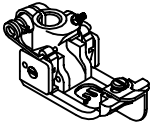

-43-

FT7013-0-□□□M

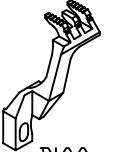
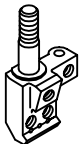
Main Parts 更換零件 針數 Needle	針距 m.m	 Throat plate 針板	 Presser foot asm 壓腳	 Main feed dog 主送布齒	 Diff feed dog 副送布齒	 Needle clamp 針留	 Upper looper 上結線鉤	 Lower looper 下結線鉤	 Needle guide 前導針	 Needle guide 後導針	 Needle 針
2	4.0	5222TP13403	5220PF00404	5221FD00567	5221DF00563	5220NC00400	5221SL00560	5221LL00561	5221NG00561	5221NG00562	UY128GAS # 11
2	4.8	5222TP13483	5220PF00484	5221FD00567	5221DF00563	5220NC00480	5221SL00560	5221LL00561	5221NG00561	5221NG00562	
3	4.8	5222TP13483	5220PF00485	5221FD00567	5221DF00563	5220NC00485	5221SL00560	5221LL00561	5221NG00561	5221NG00562	
3	5.6	5222TP13563	5220PF00564	5221FD00567	5221DF00563	5227NC00560	5221SL00560	5221LL00561	5221NG00561	5221NG00562	
3	6.4	5222TP13643	5220PF00644	5221FD00646	5221DF00643	5227NC00640	5221SL00560	5221LL00561	5221NG00561	5221NG00562	



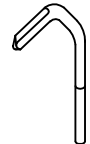



FT7000 GAUGE PARTS LIST

FT7013-1-□□□M

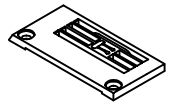
Main Parts 更換零件	針距 Needle m.m	 Throat plate 針板	 Presser foot asm 壓腳	 Main feed dog 主送布齒	 Diff feed dog 副送布齒	 Needle clamp 針留	 Upper looper 上結線鉤	 Lower looper 下結線鉤	 Needle guide 前導針	 Needle guide 後導針	 Needle 針	
												針數
	2	4.0	5222TP13404	5220PF00404	5221FD00567	5221DF13560	5220NC00400	5221SL00560	5221LL00561	5221NG00561	5221NG00562	UY128GAS # 11
	2	4.8	5222TP13484	5220PF00484	5221FD00567	5221DF13560	5220NC00480	5221SL00560	5221LL00561	5221NG00561	5221NG00562	
	3	4.8	5222TP13484	5220PF00485	5221FD00567	5221DF13560	5220NC00485	5221SL00560	5221LL00561	5221NG00561	5221NG00562	
	3	5.6	5222TP13564	5220PF00564	5221FD00567	5221DF13560	5227NC00560	5221SL00560	5221LL00561	5221NG00561	5221NG00562	
	3	6.4	5222TP13644	5220PF00644	5221FD00646	5221DF13640	5227NC00640	5221SL00560	5221LL00561	5221NG00561	5221NG00562	

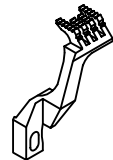
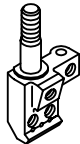
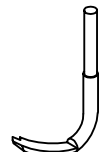
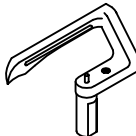





-4-

FT7013-2-□□□M

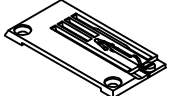
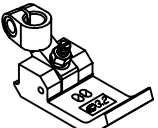
Main Parts 更換零件	針距 Needle m.m	 Throat plate 針板	 Presser foot asm 壓腳	 Main feed dog 主送布齒	 Diff feed dog 副送布齒	 Needle clamp 針留	 Upper looper 上結線鉤	 Lower looper 下結線鉤	 Needle guide 前導針	 Needle guide 後導針	 Needle 針	
												針數
	2	4.0	5222TP13402	5220PF00404	5221FD00567	5221DF00563	5220NC00400	5221SL00560	5221LL00561	5221NG00561	5221NG00562	UY128GAS # 11
	2	4.8	5222TP13482	5220PF00484	5221FD00567	5221DF00563	5220NC00480	5221SL00560	5221LL00561	5221NG00561	5221NG00562	
	3	4.8	5222TP13482	5220PF00485	5221FD00567	5221DF00563	5220NC00485	5221SL00560	5221LL00561	5221NG00561	5221NG00562	
	3	5.6	5222TP13562	5220PF00564	5221FD00567	5221DF00563	5227NC00560	5221SL00560	5221LL00561	5221NG00561	5221NG00562	
	3	6.4	5222TP13642	5220PF00644	5221FD00646	5221DF00643	5227NC00640	5221SL00560	5221LL00561	5221NG00561	5221NG00562	

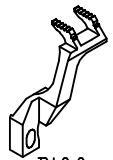
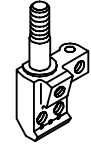
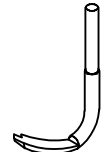
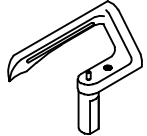

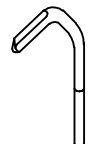



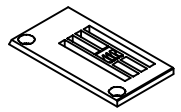
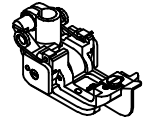

FT7000 GAUGE PARTS LIST

FT7015-0-0232M

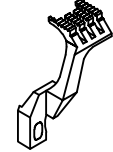
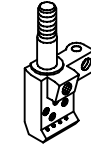
Main Parts 更換零件 針距 Needle m.m												
											Throat plate 針板	Presser foot asm 壓腳
2	3.2	5221TP15320	5221PF15320	5221FD00567 5221DG00271	5221DF15320	5221NC15320	5221SL00560	5221LL00561	5221NG00561	5221NG00562	UY128GAS #11	

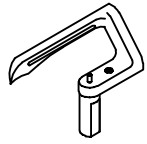
-45-

FT7060-0-4 □□M

Main Parts 更換零件 針距 Needle m.m												
											Throat plate 針板	Presser foot asm 壓腳
4	5.2	5227TP60520	5221PF60521	5221FD00646 5221DG00221	5221DF00643	5228NC60521	5221SL00560	5221LL00561	5221NG00561	5221NG00562		
4	5.6	5227TP60560	5221PF60561	5221FD00646 5221DG00221	5221DF00643	5228NC60561	5221SL00560	5221LL00561	5221NG00561	5221NG00562		
4	6.0	5227TP60600	5221PF60601	5221FD00646 5221DG00221	5221DF00643	5228NC60601	5221SL00560	5221LL00561	5221NG00561	5221NG00562		
4	6.4	5227TP60640	5221PF60641	5221FD00646 5221DG00221	5221DF00643	5228NC60641	5221SL00560	5221LL00561	5221NG00561	5221NG00562		

*

MY1014B
11

FT7000 GAUGE PARTS LIST

FT7060-0-4 □□M /KI002

Main Parts 更換零件 針 針距 數 Needle m.m	Throat plate 針板	Presser foot asm 壓腳	Main feed dog 主送布齒	Diff feed dog 副送布齒	Needle clamp 針留	Upper looper 上結線鉤	Lower looper 下結線鉤	Needle guide 前導針	Needle guide 後導針	Needle 針		
											5221FD00646	5221DF00643
4	5.2	5228TP60524	5221PF60521	5221DG00221	5228NC60521	5221SL00560	5221LL00561	5221NG00561	5221NG00562	MY1014B # 11		
4	5.6	5228TP60564	5221PF60561	5221DG00221	5228NC60561	5221SL00560	5221LL00561	5221NG00561	5221NG00562			
4	6.0	5228TP60604	5221PF60601	5221DG00221	5228NC60601	5221SL00560	5221LL00561	5221NG00561	5221NG00562			
4	6.4	5228TP60644	5221PF60641	5221DG00221	5228NC60641	5221SL00560	5221LL00561	5221NG00561	5221NG00562			

*OPTION-MAKE TO ORDER







-46-

FT7060-0-464H

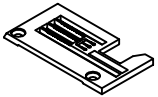
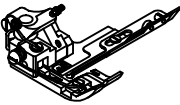
Main Parts 更換零件 針 針距 數 Needle m.m	Throat plate 針板	Presser foot asm 壓腳	Main feed dog 主送布齒	Diff feed dog 副送布齒	Needle clamp 針留	Upper looper 上結線鉤	Lower looper 下結線鉤	Needle guide 前導針	Needle guide 後導針	Needle 針		
											5221FD00646	5221DF00643
4	6.4	5228TP60645	5221PF60641	5221DG00221	5228NC60641	5221SL00560	5221LL00561	5221NG00561	5221NG00562	MY1014B # 14		

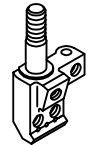
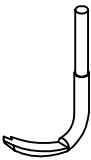
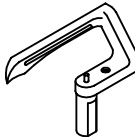

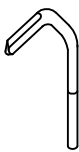



FT7000 GAUGE PARTS LIST

FT7069-0-□□□M

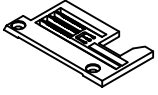
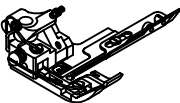
Main Parts 更換零件 針 針 數 距 Needle m.m												
											Throat plate 針板	Presser foot asm 壓腳
2	3.2	5228TP69321	5228PF69321	5228FD69561	5228DF69320	5221NC15320	5221SL00560	5221LL00561	5221NG00561	5221NG00562	UY128GAS # 11	
				5228DG00051								
2	4.0	5228TP69401	5228PF69401	5228FD69561	5228DF69320	5220NC00400	5221SL00560	5221LL00561	5221NG00561	5221NG00562		
				5228DG00051								
2	4.8	5228TP69481	5228PF69481	5228FD69561	5228DF69320	5220NC00480	5221SL00560	5221LL00561	5221NG00561	5221NG00562		
				5228DG00051								
3	5.6	5228TP69561	5228PF69561	5228FD69561	5228DF69560	5227NC00560	5221SL00560	5221LL00561	5221NG00561	5221NG00562		
				5228DG00011								
3	6.4	5228TP69641	5228PF69641	5228FD69561	5228DF69560	5227NC00640	5221SL00560	5221LL00561	5221NG00561	5221NG00562		
				5228DG00011								

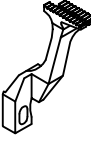
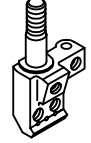
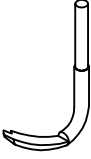
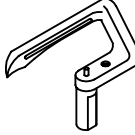





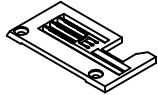
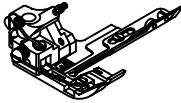

-47-

FT7069-0-□□□M/TC□09

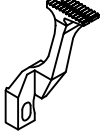
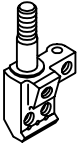
Main Parts 更換零件 針 針 數 距 Needle m.m												
											Throat plate 針板	Presser foot asm 壓腳
3	5.6	5228TP69562	5228PF69561	5228FD69561	5228DF69560	5227NC00560	5221SL00560	5221LL00561	5221NG00561	5221NG00562	UY128GAS # 11	
				5228DG00011								
3	6.4	5228TP69642	5228PF69641	5228FD69561	5228DF69560	5227NC00640	5221SL00560	5221LL00561	5221NG00561	5221NG00562		
				5228DG00011								







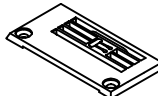
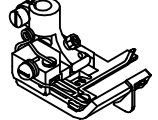

FT7000 GAUGE PARTS LIST

FT7069-0-□□□L

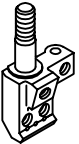
Main Parts 更換零件 針距 Needle m.m												
											Throat plate 針板	Presser foot asm 壓腳
2	3.2	5228TP69323	5228PF69321	5228FD69561	5228DF69320	5221NC15320	5221SL00560	5221LL00561	5221NG00561	5221NG00562	UY128GAS # 11	
				5228DG00051								
2	4.0	5228TP69403	5228PF69401	5228FD69561	5228DF69320	5220NC00400	5221SL00560	5221LL00561	5221NG00561	5221NG00562		
				5228DG00051								
3	5.6	5228TP69563	5228PF69561	5228FD69561	5228DF69560	5227NC00560	5221SL00560	5221LL00561	5221NG00561	5221NG00562		
				5228DG00011								
3	6.4	5228TP69643	5228PF69641	5228FD69561	5228DF69560	5227NC00640	5221SL00560	5221LL00561	5221NG00561	5221NG00562		
				5228DG00011								

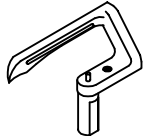
-48-

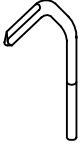





FT7069-1-□□□M

Main Parts 更換零件 針距 Needle m.m												
											Throat plate 針板	Presser foot asm 壓腳
3	5.6	5220TP00564	5221PF39561	5221FD00567	5221DF00563	5227NC00560	5221SL00560	5221LL00561	5221NG00561	5221NG00562	UY128GAS # 11	
				5221DG00211								
3	6.4	5220TP00642	5221PF39640	5221FD00646	5221DF00643	5227NC00640	5221SL00560	5221LL00561	5221NG00561	5221NG00562		
				5221DG00221								

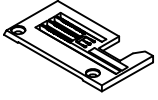
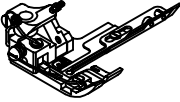
*OPTION-MAKE TO ORDER

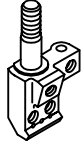
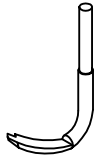
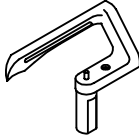





FT7000 GAUGE PARTS LIST

FT7069-2-□□□M

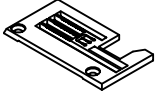
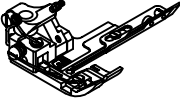
Main Parts 更換零件 針數 Needle	針距 m.m	 Throat plate 針板	 Presser foot asm 壓腳	 Main feed dog 主送布齒	 Diff feed dog 副送布齒	 Needle clamp 針留	 Upper looper 上結線鉤	 Lower looper 下結線鉤	 Needle guide 前導針	 Needle guide 後導針	 Needle 針
2	3.2	5228TP69321	5228PF69321	5228FD69561 5228DG00051	5228DF69320	5221NC15320	5221SL00560	5221LL00561	5221NG00561	5221NG00562	UY128GAS # 11
2	4.0	5228TP69401	5228PF69401	5228FD69561 5228DG00051	5228DF69320	5220NC00400	5221SL00560	5221LL00561	5221NG00561	5221NG00562	
2	4.8	5228TP69481	5228PF69481	5228FD69561 5228DG00051	5228DF69320	5220NC00480	5221SL00560	5221LL00561	5221NG00561	5221NG00562	
3	5.6	5228TP69561	5228PF69561	5228FD69561 5228DG00011	5228DF69560	5227NC00560	5221SL00560	5221LL00561	5221NG00561	5221NG00562	
3	6.4	5228TP69641	5228PF69641	5228FD69561 5228DG00011	5228DF69560	5227NC00640	5221SL00560	5221LL00561	5221NG00561	5221NG00562	

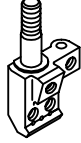
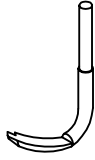
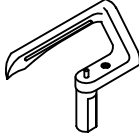

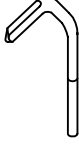



-49-

FT7069-2-□□□L

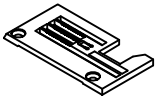
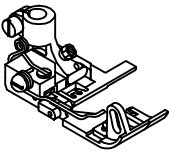
Main Parts 更換零件 針數 Needle	針距 m.m	 Throat plate 針板	 Presser foot asm 壓腳	 Main feed dog 主送布齒	 Diff feed dog 副送布齒	 Needle clamp 針留	 Upper looper 上結線鉤	 Lower looper 下結線鉤	 Needle guide 前導針	 Needle guide 後導針	 Needle 針
2	3.2	5228TP69323	5228PF69321	5228FD69561 5228DG00051	5228DF69320	5221NC15320	5221SL00560	5221LL00561	5221NG00561	5221NG00562	UY128GAS # 11
2	4.0	5228TP69403	5228PF69401	5228FD69561 5228DG00051	5228DF69320	5220NC00400	5221SL00560	5221LL00561	5221NG00561	5221NG00562	
3	5.6	5228TP69563	5228PF69561	5228FD69561 5228DG00011	5228DF69560	5227NC00560	5221SL00560	5221LL00561	5221NG00561	5221NG00562	
3	6.4	5228TP69643	5228PF69641	5228FD69561 5228DG00011	5228DF69560	5227NC00640	5221SL00560	5221LL00561	5221NG00561	5221NG00562	

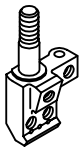
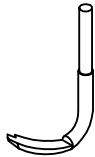

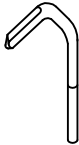



FT7000 GAUGE PARTS LIST

FT7069-3-□□□M

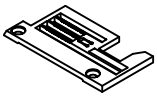
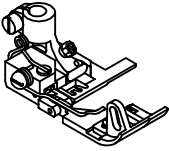
Main Parts 更換零件 針數 Needle	針距 m.m										
2	3.2	5228TP69325	5228PF69325	5228FD69561	5228DF69325	5221NC15320	5221SL00560	5221LL00561	5221NG00561	5221NG00562	UY128GAS # 11
				5228DG00061							

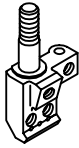
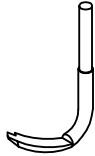
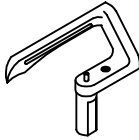





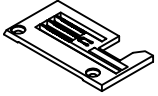
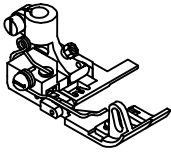

-50-

FT7069-3-□□□M/TC□19

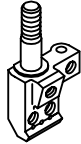
Main Parts 更換零件 針數 Needle	針距 m.m										
2	3.2	5228TP69326	5228PF69325	5228FD69561	5228DF69325	5221NC15320	5221SL00560	5221LL00561	5221NG00561	5221NG00562	UY128GAS # 11
				5228DG00061							

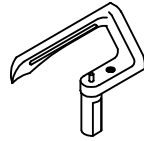





FT7000 GAUGE PARTS LIST

FT7069-3A-□□□M

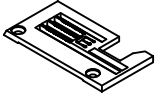
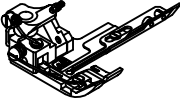
Main Parts 更換零件 針數 Needle	針距 m.m										
2	3.2	5228TP69325	5228PF69325	5228FD69561	5228DF69325	5221NC15320	5221SL00560	5221LL00561	5221NG00561	5221NG00562	UY128GAS # 11
				5228DG00061							

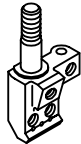
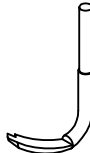
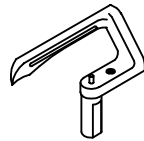
-51-

FT7069-4-□□□M

Main Parts 更換零件 針數 Needle	針距 m.m										
2	3.2	5228TP69321	5228PF69321	5228FD69561	5228DF69320	5221NC15320	5221SL00560	5221LL00561	5221NG00561	5221NG00562	UY128GAS # 11
				5228DG00051							
2	4.0	5228TP69401	5228PF69401	5228FD69561	5228DF69320	5220NC00400	5221SL00560	5221LL00561	5221NG00561	5221NG00562	
				5228DG00051							
2	4.8	5228TP69481	5228PF69481	5228FD69561	5228DF69320	5220NC00480	5221SL00560	5221LL00561	5221NG00561	5221NG00562	
				5228DG00051							
3	5.6	5228TP69561	5228PF69561	5228FD69561	5228DF69560	5227NC00560	5221SL00560	5221LL00561	5221NG00561	5221NG00562	
				5228DG00011							
3	6.4	5228TP69641	5228PF69641	5228FD69561	5228DF69560	5227NC00640	5221SL00560	5221LL00561	5221NG00561	5221NG00562	
				5228DG00011							

FT7000 GAUGE PARTS LIST

FT7069-4-□□□L

針 數 Needle	針 距 m.m	Main Parts 更換 零件		Main feed dog 主送布齒	Diff feed dog 副送布齒	Needle clamp 針留	Upper looper 上結線鉤	Lower looper 下結線鉤	Needle guide 前導針	Needle guide 後導針	Needle 針
		Throat plate 針板	Presser foot asm 壓腳								
2	3.2	5228TP69323	5228PF69321	5228FD69561	5228DF69320	5221NC15320	5221SL00560	5221LL00561	5221NG00561	5221NG00562	UY128GAS # 11
				5228DG00051							
2	4.0	5228TP69403	5228PF69401	5228FD69561	5228DF69320	5220NC00400	5221SL00560	5221LL00561	5221NG00561	5221NG00562	
				5228DG00051							
3	5.6	5228TP69563	5228PF69561	5228FD69561	5228DF69560	5227NC00560	5221SL00560	5221LL00561	5221NG00561	5221NG00562	
				5228DG00011							
3	6.4	5228TP69643	5228PF69641	5228FD69561	5228DF69560	5227NC00640	5221SL00560	5221LL00561	5221NG00561	5221NG00562	







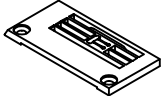

-52-

FT7069-5-□□□M

針 數 Needle	針 距 m.m	Main Parts 更換 零件		Main feed dog 主送布齒	Diff feed dog 副送布齒	Needle clamp 針留	Upper looper 上結線鉤	Lower looper 下結線鉤	Needle guide 前導針	Needle guide 後導針	Needle 針
		Throat plate 針板	Presser foot asm 壓腳								
2	3.2	5228TP69325	5228PF69325	5228FD69561	5228DF69325	5221NC15320	5221SL00560	5221LL00561	5221NG00561	5221NG00562	UY128GAS # 11
				5228DG00061							

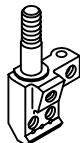
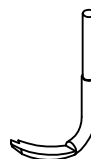
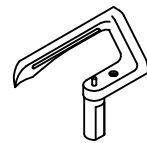
FT7000 GAUGE PARTS LIST

FT7200-0-0□□□H
 FT7200-0-□□□H

Main Parts 更換零件 針數 Needle	針距 m.m	 Throat plate 針板	 Presser foot asm 壓腳	 Main feed dog 主送布齒	 Diff feed dog 副送布齒	 Needle clamp 針留	 Upper looper 上結線鉤	 Lower looper 下結線鉤	 Needle guide 前導針	 Needle guide 後導針	 Needle 針
3	5.6	5220TP00567	5220PF00563	5221FD00568 5221DG00161	5221DF00561	5227NC00560	5221SL00560	5221LL00561	5221NG00561	5221NG00562	UY128GAS # 14
3	6.4	5220TP00645	5220PF00643	5221FD00568 5221DG00161	5221DF00561	5227NC00640	5221SL00560	5221LL00561	5221NG00561	5221NG00562	UY128GAS # 14



NTD7701
4-Needle, 6-Thread Flat-Seamer,
Feed-Off-The-Arm Machine



MT4512P-050 / PMD / FR01
12-Needle Double Chain Stitch Machine
(Lower Feed Metering Device \ Elastic hemmer)



UHU9304/TR025
Automatic chain cutter device direct-drive
cylinder bed top feed overlock fitted with
labor-saving rib folder



CXM2085-0-356M
Attaching Pre-Closed Flat Knit Elastic Band Onto
Waists Of Tubular Goods
(With Right Knife, Rear Puller & Chips Suction Pipe)



精機機械廠股份有限公司
CHING CHI MACHINE CO., LTD
<http://www.kingtexsewing.com.tw>

The specifications and / or appearances of the equipments described in
this catalogue are subject to change without further notice.

本目錄所述產品，因更新或改良，可能不經事前預告，而對產品之外觀，規格，內容進行修改，特此聲明敬請鑒諒。